

LSA 52.3

Low Voltage Alternator - 4 pole

1860 to 2750 kVA - 50 Hz / 2230 to 3400 kVA - 60 Hz
Electrical and mechanical data

LEROY-SOMER[™]

Nidec
All for dreams

Specially adapted to applications

The LSA 52.3 alternator is designed to be suitable for typical generator applications, such as: backup, marine applications, rental, telecommunications, etc.

Compliant with international standards

The LSA 52.3 alternator conforms to the main international standards and regulations:

- IEC 60034, NEMA MG 1.32-33, ISO 8528-3, CSA C22.2 n°100-14, UL 1446 (UL 1004 on request), marine regulations, etc.

It can be integrated into a CE marked generator.

The LSA 52.3 is designed, manufactured and marketed in an ISO 9001 and ISO 14001 environment.

Top of the range electrical performance

- Class H insulation
- Standard 6-wire winding, 2/3 pitch, type no. 6S
- Voltage range 50 Hz: 380V - 400V - 415V - 440 V
- Voltage range 60 Hz: 380V - 416V - 440V - 480V
- High efficiency and motor starting capacity
- Other voltages are possible with optional adapted windings
 - 50 Hz : 440 V (no. 7S), 500 V (no. 9S), 600 V (no. 22S or 23S), 690 V (no. 10S or 52S)
 - 60 Hz : 380 V and 416 V (no. 8S), 600 V (no. 9S)
- R 791 interference suppression conforming to standard EN 61000-6-3, EN 61000-6-2, EN 55011 group 1 class B standard for European zone (CE marking)

Advanced control system

The standard excitation system for the LSA 52.3 is an AREP + PMI auxiliary winding with permanent magnets.

The system is operated by a fully configurable D510C digital automatic voltage regulator.

The system also uses three-phase detection for precise and reactive regulation.

Options:

- Equipment for mains paralleling
- PMG excitation system
- Remote voltage potentiometer

Protection system suited to the environment

- The LSA 52.3 is IP 23
- Standard winding protection for clean environments with relative humidity $\leq 95\%$, including indoor marine environments.
 - Options : - Filters on air inlet : derating 5%
 - Filters on air inlet and air outlet (IP 44) : derating 8%
 - Winding protections for harsh environments and relative humidity greater than 95%
 - Space heaters
 - Protection or metering CTs
 - Thermal protection for stator windings &/or bearings (PT100)

Reinforced mechanical structure using finite element modelling

- Compact and rigid assembly to better withstand generator vibrations
- Steel frame
- Cast iron flanges and shields
- Twin-bearing and single-bearing versions designed to be suitable for engines on the market
- Half-key balancing
- Regreasable bearings
- Clockwise rotation in standard

Accessible terminal box proportioned for optional equipment

- Easy access to the voltage regulator and to the connections
- Possible inclusion of accessories for paralleling, protection and measurement

General characteristics

Insulation class	H	Excitation system	AREP + PMI
Winding pitch	2/3 (n° 6S)	AVR type	D510 C
Number of wires	6	Voltage regulation (*)	± 0.5%
Protection	IP 23	Short-circuit current	300% (3 IN) : 10s
Altitude	≤ 1000 m	Total Harmonic Distortion THD (**) in no-load:	< 4%
Overspeed	2250 min ⁻¹	Waveform: NEMA = TIF (**)	< 50
Air flow	2.5 m ³ /s (50 Hz) - 2.8 m ³ /s (60 Hz)	Waveform: I.E.C. = THF (**)	< 2%

(*) steady state (**) between phases

Ratings 50 Hz - 1500 R.P.M.

kVA / kW - P.F. = 0.8																	
Duty/T°C		Continuous duty/40°C				Continuous duty/40°C				Stand-by/40°C				Stand-by/27°C			
Class/T°K		H/125°K				F/105°K				H/150°K				H/163°K			
Phase		3 ph.				3 ph.				3 ph.				3 ph.			
Y		380V	400V	415V	440V	380V	400V	415V	440V	380V	400V	415V	440V	380V	400V	415V	440V
LSA 52.3 S5	kVA	1860	1691	1696	1542	1953	1775	2046	1860								
	kW	1488	1353	1357	1234	1562	1420	1637	1488								
LSA 52.3 S6	kVA	2000	1818	1824	1658	2100	1909	2200	2000								
	kW	1600	1454	1459	1326	1680	1527	1760	1600								
LSA 52.3 S7	kVA	2200	2000	2006	1824	2310	2100	2420	2200								
	kW	1760	1600	1605	1459	1848	1680	1936	1760								
LSA 52.3 L9	kVA	2360	2145	2152	1956	2478	2253	2596	2360								
	kW	1888	1716	1722	1565	1982	1802	2077	1888								
LSA 52.3 L12	kVA	2560	2327	2335	2123	2688	2444	2816	2560								
	kW	2048	1862	1868	1698	2150	1955	2253	2048								
LSA 52.3 UL16	kVA	2750	2500	2508	2280	2888	2625	3025	2750								
	kW	2200	2000	2006	1824	2310	2100	2420	2200								

Ratings 60 Hz - 1800 R.P.M.

kVA / kW - P.F. = 0.8																	
Duty/T°C		Continuous duty/40°C				Continuous duty/40°C				Stand-by/40°C				Stand-by/27°C			
Class/T°K		H/125°K				F/105°K				H/150°K				H/163°K			
Phase		3 ph.				3 ph.				3 ph.				3 ph.			
Y		380V	416V	440V	480V	380V	416V	440V	480V	380V	416V	440V	480V	380V	416V	440V	480V
LSA 52.3 S5	kVA	1860	1934	2046	2232	1697	1765	1866	2036	1953	2031	2149	2344	2046	2128	2250	2455
	kW	1488	1547	1637	1786	1358	1412	1493	1629	1562	1625	1719	1875	1637	1702	1800	1964
LSA 52.3 S6	kVA	2000	2080	2200	2400	1824	1897	2007	2189	2100	2184	2310	2520	2200	2288	2420	2640
	kW	1600	1664	1760	1920	1459	1518	1606	1751	1680	1747	1848	2016	1760	1830	1936	2112
LSA 52.3 S7	kVA	2200	2288	2420	2640	2007	2087	2207	2408	2310	2402	2541	2772	2420	2517	2662	2904
	kW	1760	1830	1936	2112	1606	1670	1766	1926	1848	1922	2033	2218	1936	2014	2130	2323
LSA 52.3 L9	kVA	2360	2454	2596	2832	2153	2239	2368	2583	2478	2577	2726	2974	2596	2700	2855	3115
	kW	1888	1963	2077	2266	1722	1791	1894	2066	1982	2062	2181	2379	2077	2160	2284	2492
LSA 52.3 L12	kVA	2708	2817	2979	3250	2470	2569	2717	2964	2844	2958	3129	3413	2979	3098	3277	3575
	kW	2166	2254	2383	2600	1976	2055	2174	2371	2275	2366	2503	2730	2383	2478	2622	2860
LSA 52.3 UL16	kVA	2833	2947	3117	3400	2584	2688	2843	3101	2975	3094	3273	3570	3117	3241	3428	3740
	kW	2266	2358	2494	2720	2067	2150	2274	2481	2380	2475	2618	2856	2494	2593	2742	2992

Efficiencies 400V - 50 Hz (— P.F.: 1) (----- P.F.: 0.8)

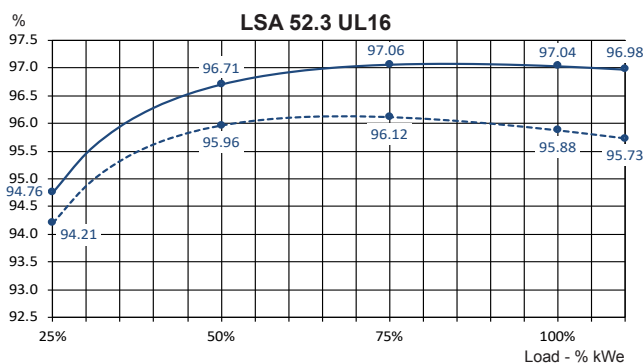
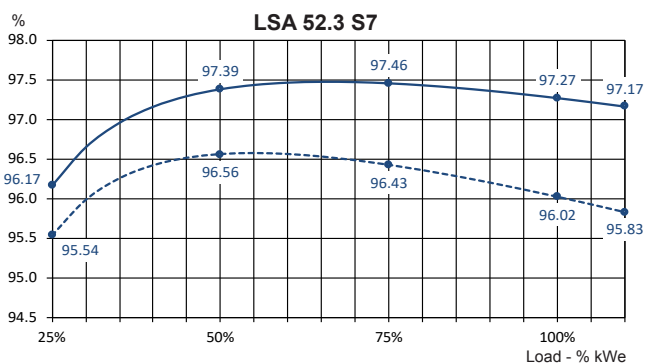
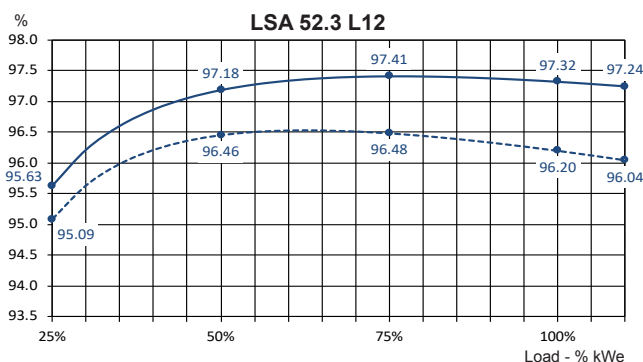
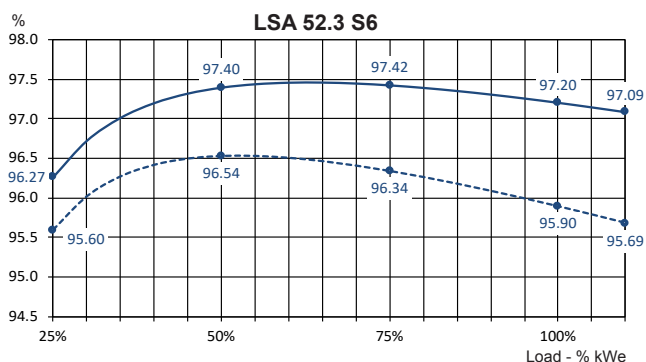
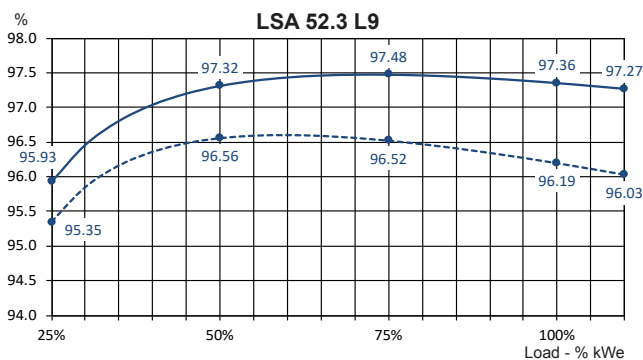
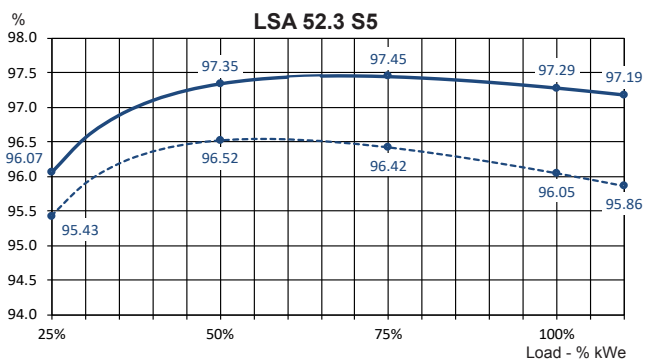

Reactances (%). Time constants (ms) - Class H / 400 V

	S5	S6	S7	L9	L12	UL16
Kcc Short-circuit ratio	0.35	0.32	0.35	0.39	0.42	0.51
Xd Direct-axis synchronous reactance unsaturated	367	380	376	344	313	267
Xq Quadrature-axis synchronous reactance unsaturated	187	194	192	175	160	136
T'do No-load transient time constant	2760	2760	2870	2990	2760	2920
X'd Direct-axis transient reactance saturated	28.7	30.9	28.9	26.1	23.6	20.3
T'd Short-circuit transient time constant	254	264	260	267	245	261
X''d Direct-axis subtransient reactance saturated	15	16.4	14.8	13.2	12.1	10.5
T''d Subtransient time constant	23	23	22	22	13	14
X''q Quadrature-axis subtransient reactance saturated	15.6	16.9	15.4	13.7	12.5	10.8
X0 Zero sequence reactance unsaturated	2.3	2.5	2.6	2.5	2.7	2.6
X2 Negative sequence reactance saturated	15.3	16.7	15.1	13.4	12.3	10.6
Ta Armature time constant	28	28	28	28	29	30

Other class H/400 V data

io (A) No-load excitation current	1.2	1.2	1.2	1.2	1.3	1.4
ic (A) On-load excitation current	4.2	4.5	4.4	4.2	4	3.7
uc (V) On-load excitation voltage	45	47	47	44	42	38
kW No-load losses	15	15	17	20	24	26
kW Heat dissipation	68	76	79.5	79.2	81	100

Transient voltage variation at load inrush: 400V - 50 Hz

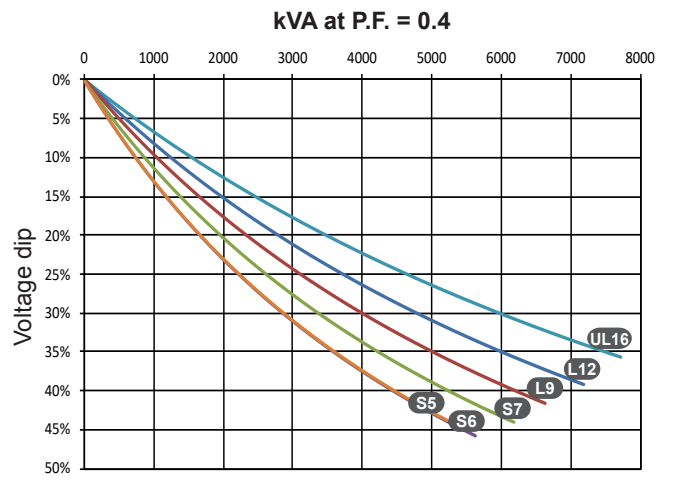
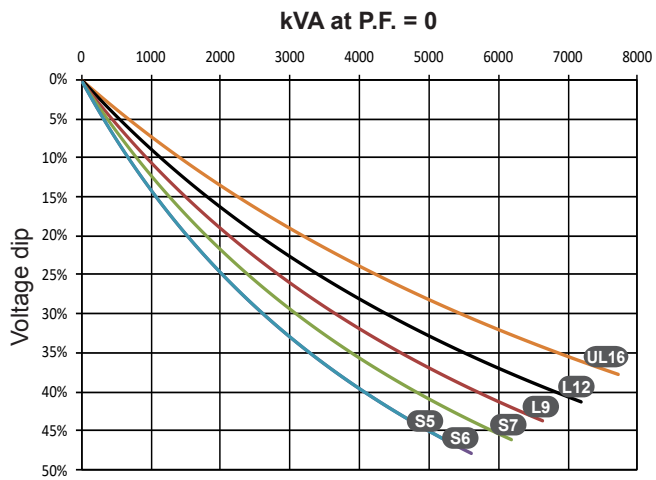
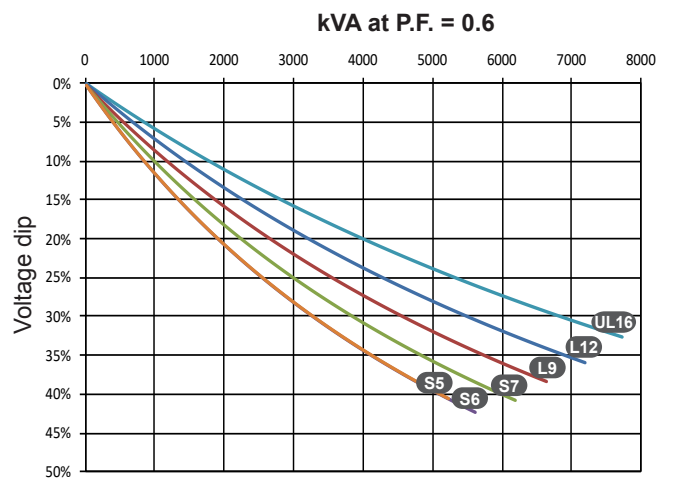
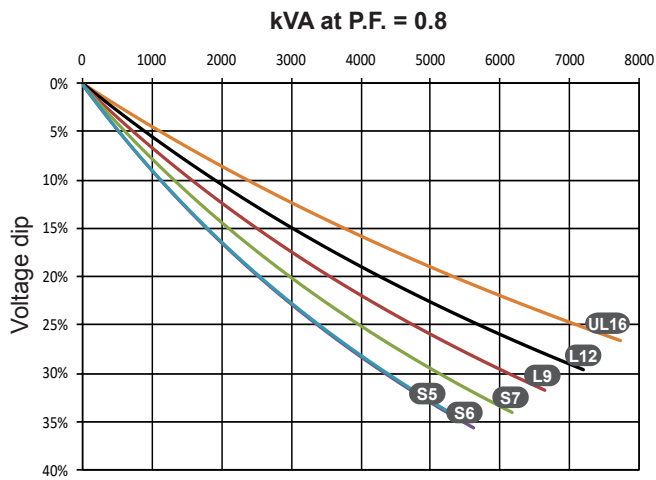

Transient voltage variation at load rejection: 400V - 50 Hz

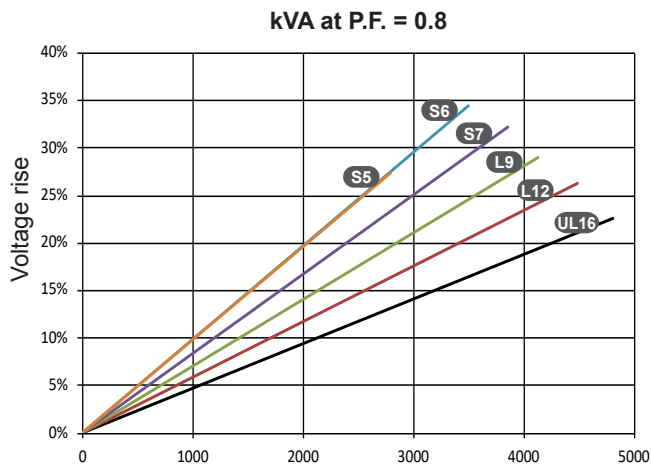

Efficiencies 480V - 60 Hz (— P.F.: 1) (----- P.F.: 0.8)

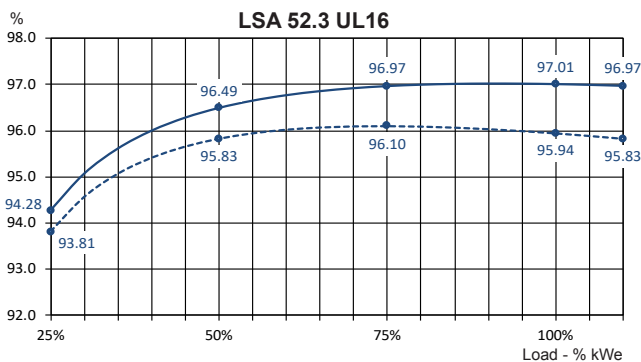
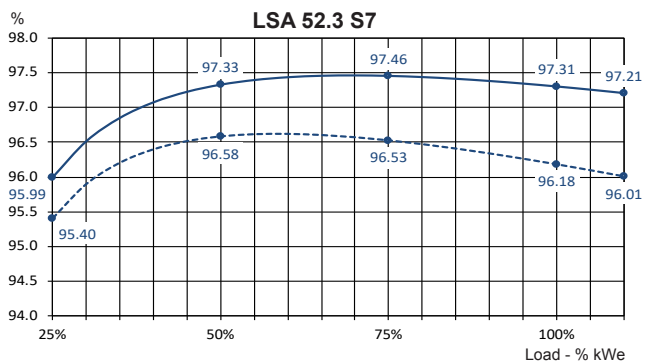
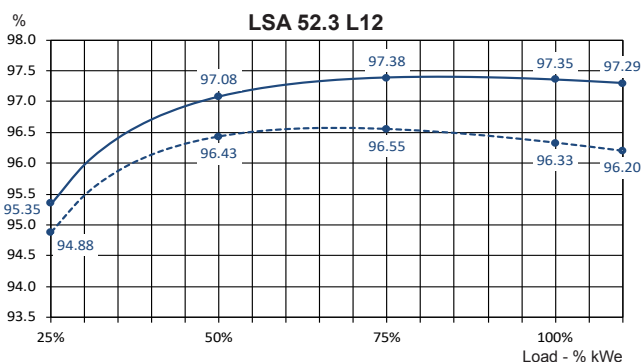
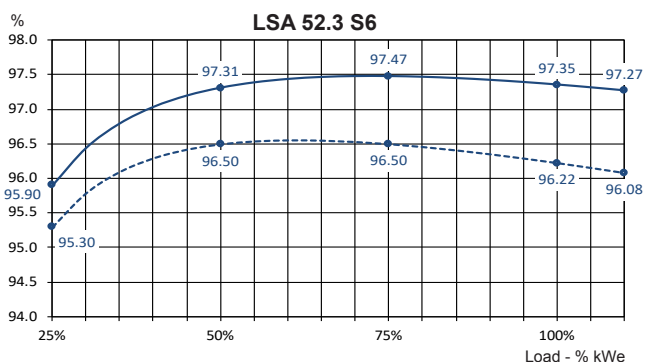
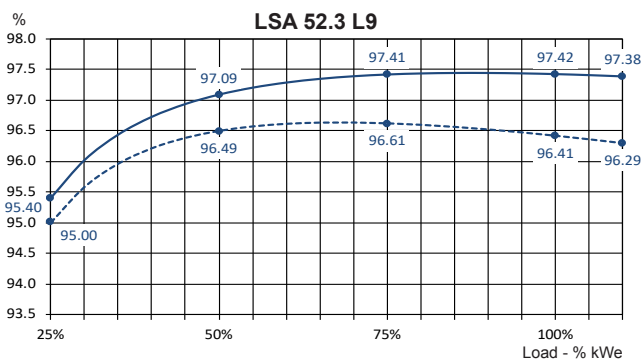
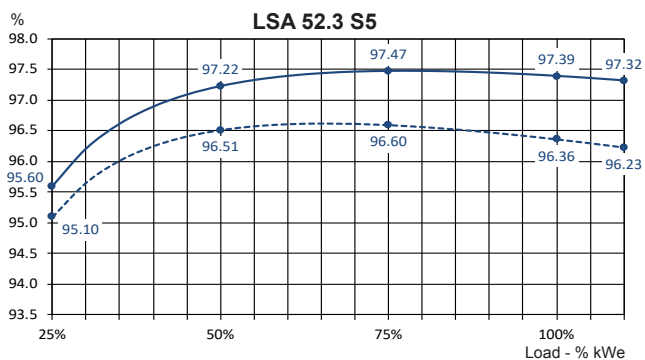

Reactances (%). Time constants (ms) - Class H / 480 V

	S5	S6	S7	L9	L12	UL16
Kcc Short-circuit ratio	0.35	0.32	0.35	0.39	0.40	0.49
Xd Direct-axis synchronous reactance unsaturated	367	380	376	344	331	275
Xq Quadrature-axis synchronous reactance unsaturated	187	194	192	175	169	140
T'do No-load transient time constant	2760	2760	2870	2990	2760	2920
X'd Direct-axis transient reactance saturated	28.7	30.9	28.9	26.1	25	20.9
T'd Short-circuit transient time constant	254	265	260	267	245	261
X''d Direct-axis subtransient reactance saturated	15	16.4	14.8	13.2	12.8	10.8
T''d Subtransient time constant	23	23	22	22	13	14
X''q Quadrature-axis subtransient reactance saturated	15.6	16.9	15.4	13.7	13.2	11.1
X0 Zero sequence reactance unsaturated	2.3	2.6	2.6	2.5	2.9	2.7
X2 Negative sequence reactance saturated	15.3	16.7	15.1	13.4	13	11
Ta Armature time constant	28	28	28	28	29	30

Other class H/480 V data

io (A) No-load excitation current	1.1	1.1	1.2	1.2	1.2	1.3
ic (A) On-load excitation current	4	4.3	4.3	4	4	3.6
uc (V) On-load excitation voltage	43	46	45	43	42	36
kW No-load losses	21	21	24	28	33	36
kW Heat dissipation	73	82	86	87	96	120

Transient voltage variation at load inrush: 480V - 60 Hz

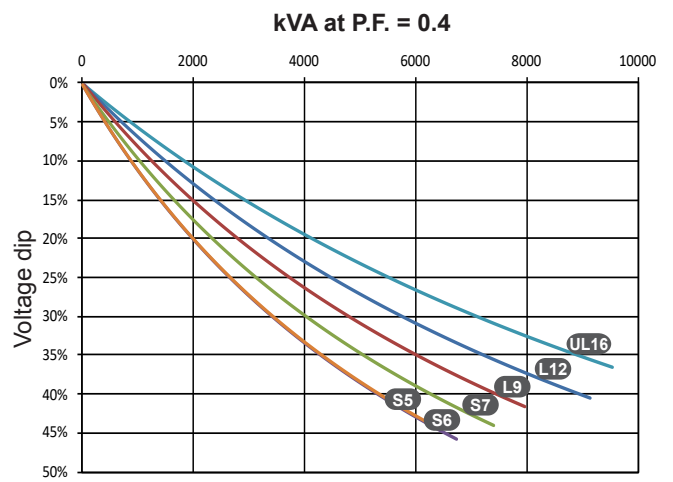
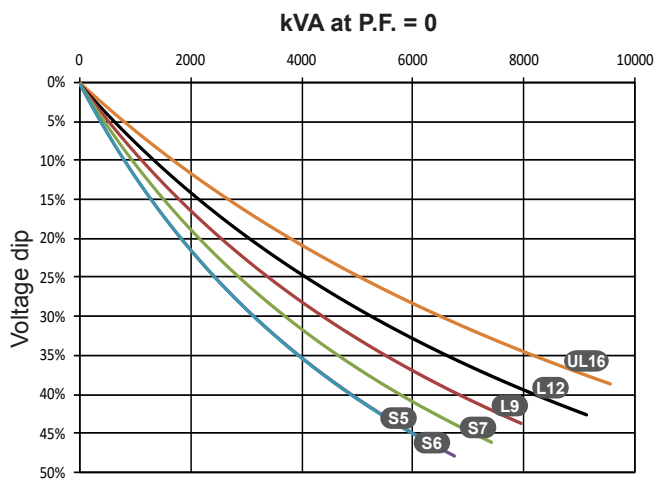
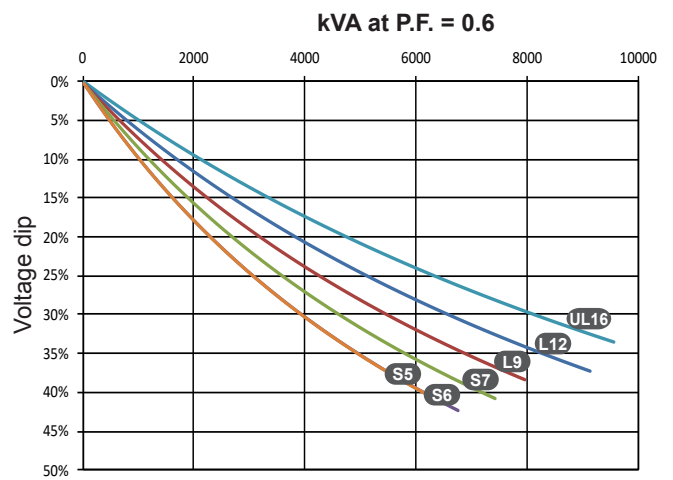
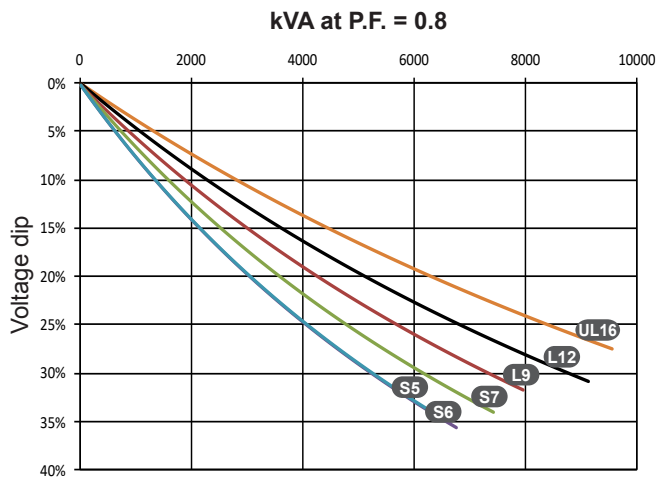

Transient voltage variation at load rejection: 480V - 60 Hz

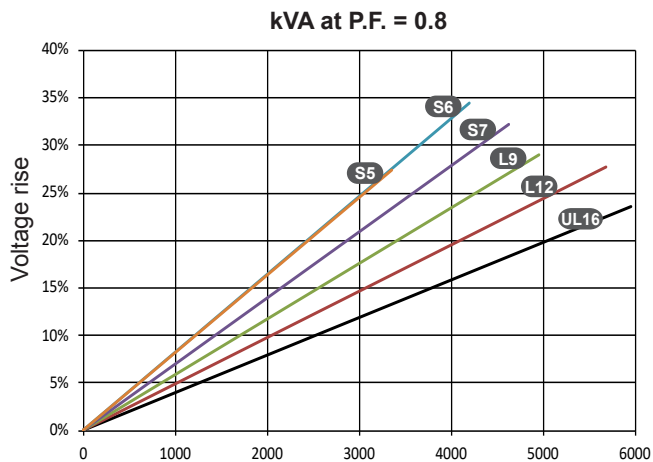

ISC - Short-circuit current per rated current

LSA 52.3 S5

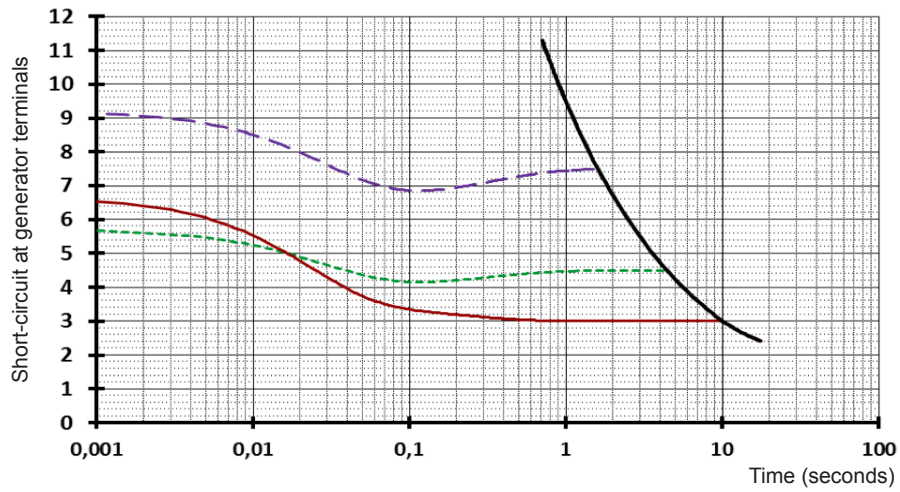

LSA 52.3 S6

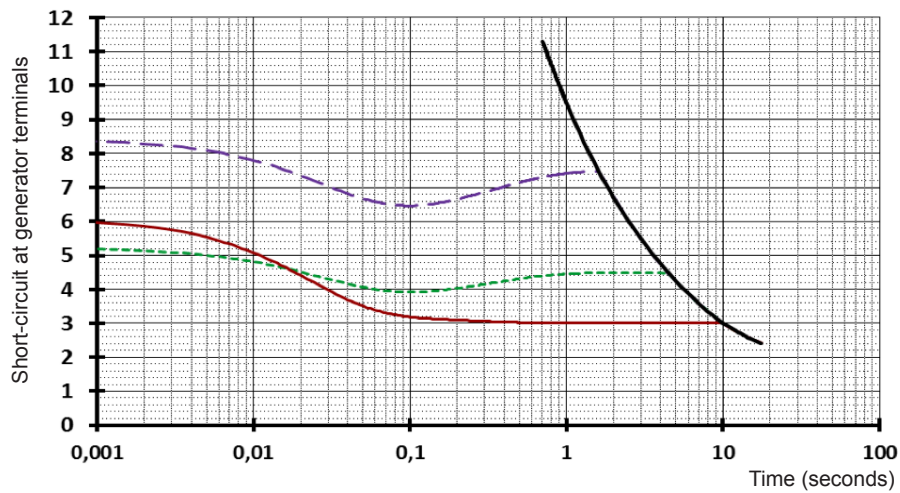

LSA 52.3 S7

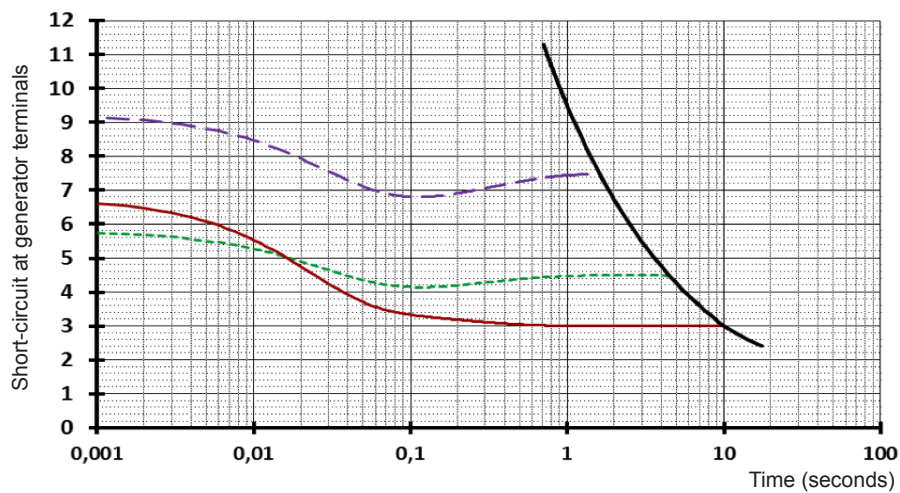

- — Symetrical phase to neutral short-circuit
- - - Symetrical two-phase short-circuit
- — Symetrical three-phase short-circuit
- — Thermal limit curve

ISC - Short-circuit current per rated current

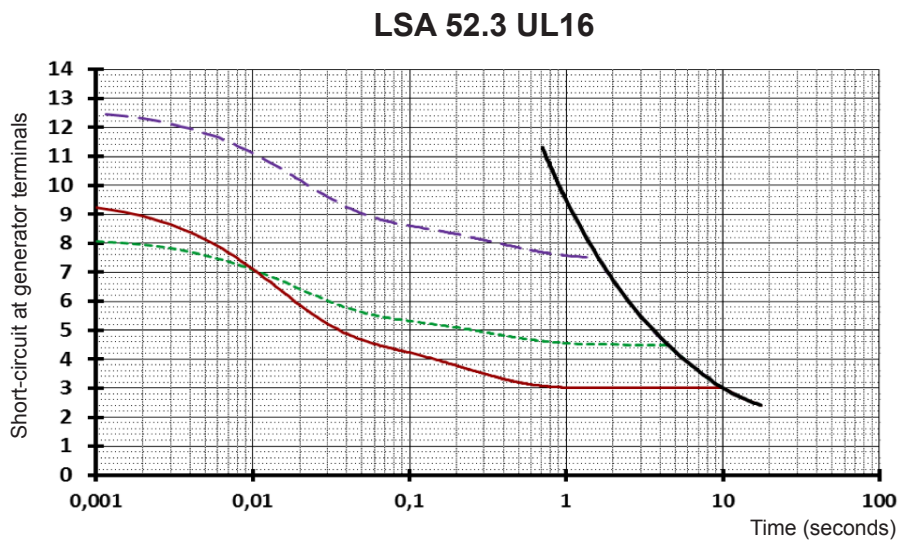
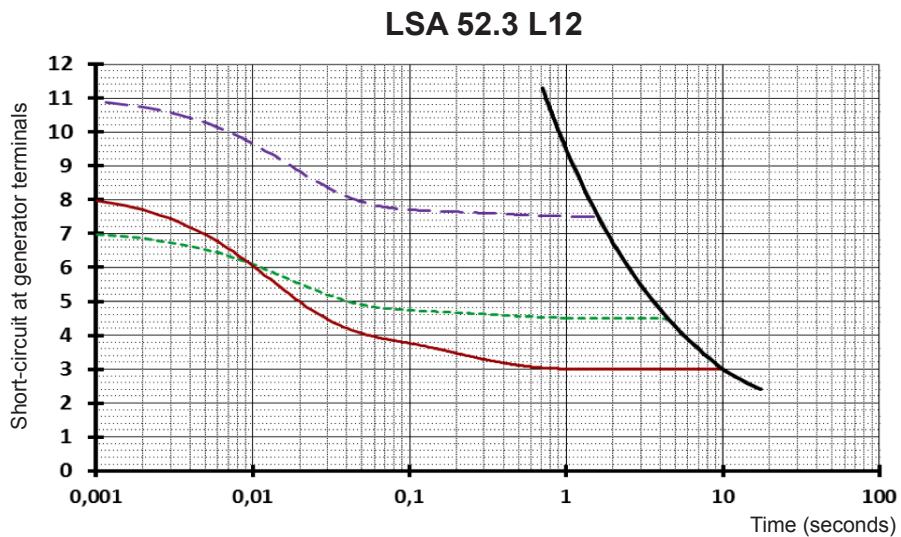
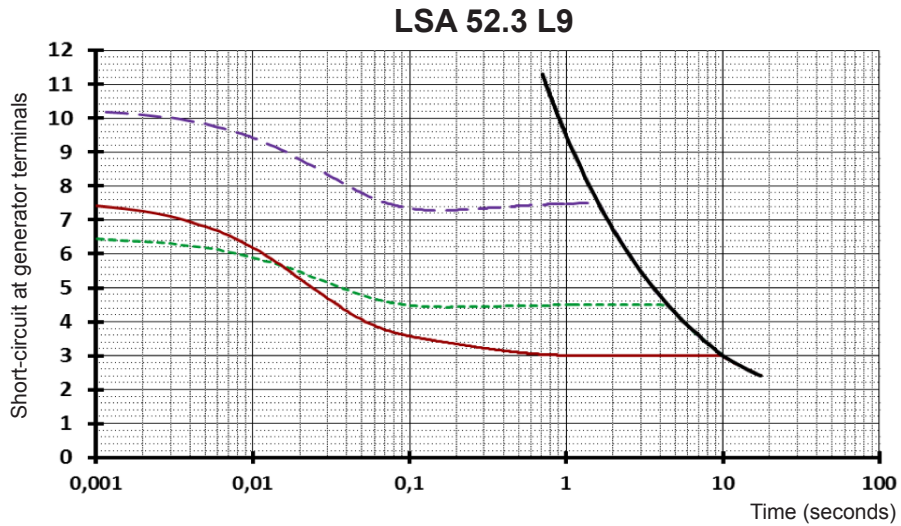

- — Symetrical phase to neutral short-circuit
- - - Symetrical two-phase short-circuit
- — Symetrical three-phase short-circuit
- — Thermal limit curve

Single bearing dimensions

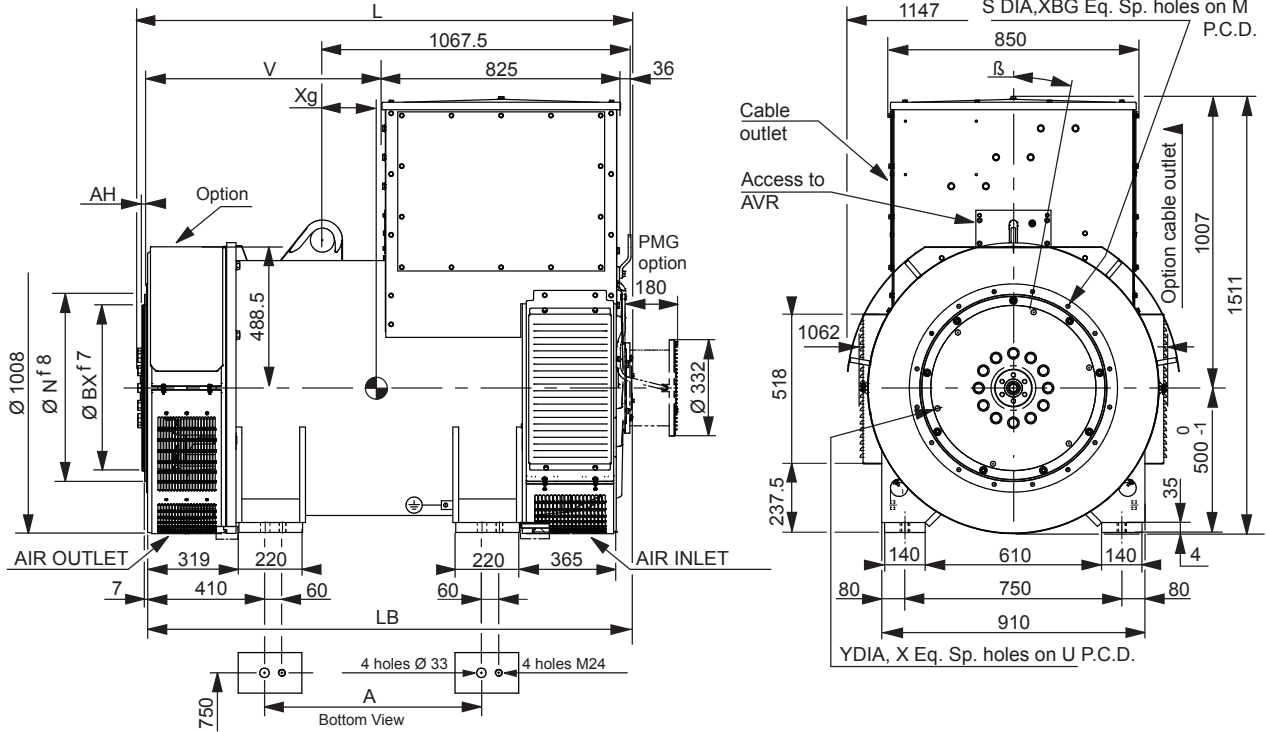

Dimensions (mm) and weight						
Type	L without PMG	LB	A	V	Xg	Weight (*) (kg)
LSA 52.3 S5	1713	1683	750	814	187	3705
LSA 52.3 S6	1713	1683	750	814	187	3705
LSA 52.3 S7	1713	1683	750	814	207	3950
LSA 52.3 L9	1913	1883	950	1014	78	4433
LSA 52.3 L12	1913	1883	950	1014	112	4924

Coupling		
Flange S.A.E.	0	00
Flex plate S.A.E. 21	X	X
Flex plate S.A.E. 18	X	X

LSA 52.3 UL16 (consult us)
 (*) values for S.A.E. 00/21

Flange (mm)					
S.A.E.	N	M	XBG	S	β°
0	647.7	679.5	16	14	11°15'
00	787.4	850.9	16	14	11°15'

Flex plate (mm)					
S.A.E.	BX	U	X	Y	AH
21	673.1	641.3	12	18	0
18	571.5	542.9	6	18	15.8

Torsional analysis data

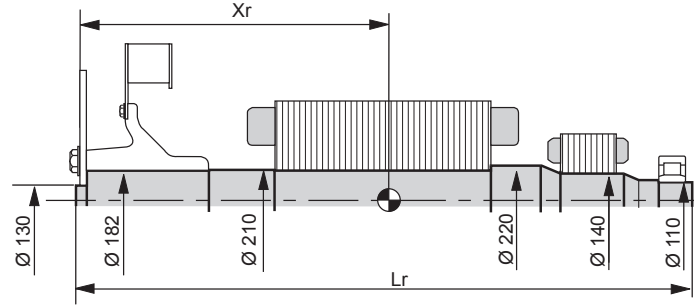
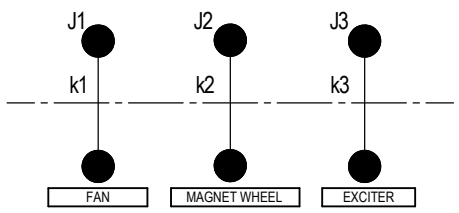

Flex plate	Centre of gravity: Xr (mm), Rotor length: Lr (mm), Weight: M (kg), Moment of inertia: J (kgm ²) : (4J = MD ²)							
	S.A.E. 18				S.A.E. 21			
Type	Xr	Lr	M	J	Xr	Lr	M	J
LSA 52.3 S5	720.4	1689	1420	43.4	702.8	1689	1424	44.3
LSA 52.3 S6	720.4	1689	1420	43.4	702.8	1689	1424	44.3
LSA 52.3 S7	741.5	1689	1453	45	723.9	1689	1457	45.9
LSA 52.3 L9	811.3	1889	1635	50	793.7	1889	1639	50.9
LSA 52.3 L12	858.4	1889	1808	56.5	840.9	1889	1812	57.4

Torsional rigidity					
[Nm/rad]			(kg.m ²)		
k1	k2	k3	J1	J2	J3
5.00 10E7	2.50 10E7	1.54 10E7	10.3	32.4	1.5
5.00 10E7	2.50 10E7	1.54 10E7	10.3	32.4	1.5
5.00 10E7	2.41 10E7	1.59 10E7	10.3	34.1	1.5
5.00 10E7	2.29 10E7	1.42 10E7	10.3	39	1.6
5.00 10E7	2.14 10E7	1.52 10E7	10.3	45.6	1.4

LSA 52.3 UL16 (consult us)

NOTE : Dimensions are for information only and may be subject to modifications. Contractual 2D drawings can be downloaded from the Leroy-Somer site, 3D drawing files are available upon request. The torsional analysis of the transmission is imperative. All values are available upon request.

Two bearing dimensions

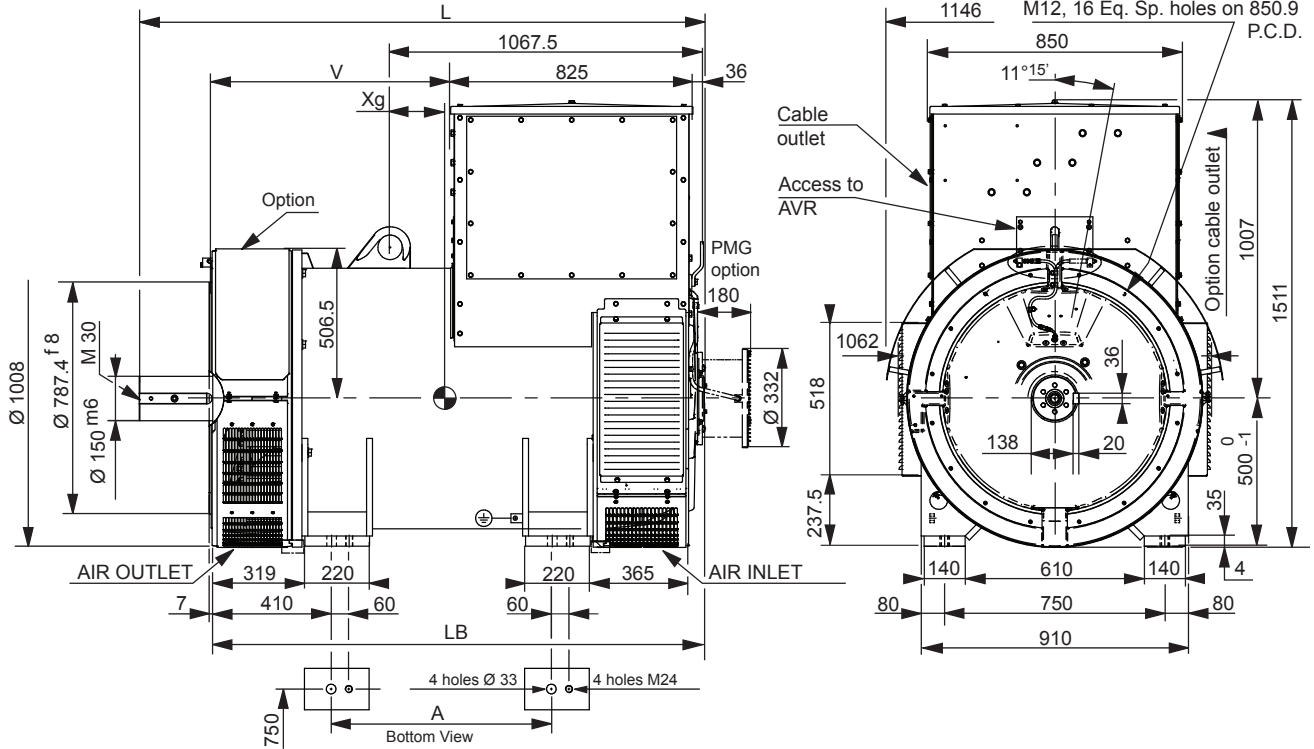

Dimensions (mm) and weight						
Type	L without PMG	LB	A	V	Xg	Weight (kg)
LSA 52.3 S5	1933	1683	750	814	192	3748
LSA 52.3 S6	1933	1683	750	814	192	3748
LSA 52.3 S7	1933	1683	750	814	212	3991
LSA 52.3 L9	2133	1883	950	1014	83	4476
LSA 52.3 L12	2133	1883	950	1014	117	4967

LSA 52.3 UL16 (consult us)

Torsional analysis data

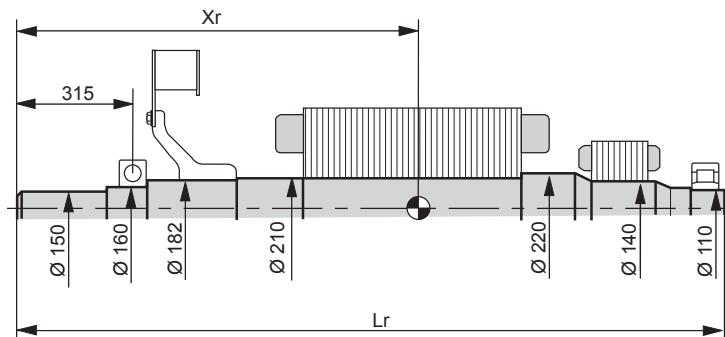
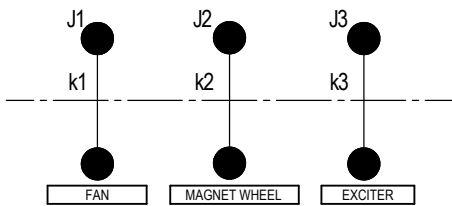

Centre of gravity: Xr (mm), Rotor length: Lr (mm), Weight: M (kg), Moment of inertia: J (kgm²) : (4J = MD²)

Torsional rigidity

Type	Xr	Lr	M	J
LSA 52.3 S5	973.4	1912	1363	41.7
LSA 52.3 S6	973.4	1912	1363	41.7
LSA 52.3 S7	994.5	1912	1396	43.3
LSA 52.3 L9	1064.3	2112	1578	48.3
LSA 52.3 L12	1110.6	2112	1752	54.8

Torsional rigidity					
[Nm/rad]			(kg.m ²)		
k1	k2	k3	J1	J2	J3
1.82 10E7	3.05 10E7	1.54 10E7	7.7	32.4	1.5
1.82 10E7	3.05 10E7	1.54 10E7	7.7	32.4	1.5
1.82 10E7	2.91 10E7	1.59 10E7	7.7	34.1	1.5
1.82 10E7	2.74 10E7	1.42 10E7	7.7	39	1.6
1.82 10E7	2.53 10E7	1.52 10E7	7.7	45.6	1.4

LSA 52.3 UL16 (consult us)

NOTE : Dimensions are for information only and may be subject to modifications. Contractual 2D drawings can be downloaded from the Leroy-Somer site, 3D drawing files are available upon request. The torsional analysis of the transmission is imperative. All values are available upon request.

LEROY-SOMER[™]

www.leroy-somer.com/epg

[Linkedin.com/company/Leroy-Somer](https://www.linkedin.com/company/Leroy-Somer)
[Twitter.com/Leroy_Somer_en](https://twitter.com/Leroy_Somer_en)
[Facebook.com/LeroySomer.Nidec.en](https://www.facebook.com/LeroySomer.Nidec.en)
[YouTube.com/LeroySomerOfficiel](https://www.youtube.com/LeroySomerOfficiel)



Nidec
All for dreams

© Nidec 2017. The information contained in this brochure is for guidance only and does not form part of any contract. The accuracy cannot be guaranteed as Nidec have an ongoing process of development and reserve the right to change the specification of their products without notice.

Moteurs Leroy-Somer SAS. Siège : Bd Marcellin Leroy, CS 10015, 16915 Angoulême Cedex 9, France.
Capital social : 65 800 512 €, RCS Angoulême 338 567 258.