



# **DEEP SEA ELECTRONICS**

## **DSE9XX, DSE91XX, DSE92XX & DSE94XX**

### **SERIES BATTERY CHARGER OPERATOR**

### **MANUAL**

**Document Number: 057-085**

Author: Ashley Senior





Deep Sea Electronics Ltd  
Highfield House  
Hunmanby  
North Yorkshire  
YO14 0PH  
ENGLAND

Sales Tel: +44 (0) 1723 890099

E-mail: sales@deepseaelectronics.com  
Website: www.deepseaelectronics.com

### **DSE9XX, 91XX, 92XX & 94XX Series Battery Charger Operator Manual**

© Deep Sea Electronics Ltd

All rights reserved. No part of this publication may be reproduced in any material form (including photocopying or storing in any medium by electronic means or other) without the written permission of the copyright holder except in accordance with the provisions of the Copyright, Designs and Patents Act 1988.

Applications for the copyright holder's written permission to reproduce any part of this publication should be addressed to Deep Sea Electronics Ltd at the address above.

Any reference to trademarked product names used within this publication is owned by their respective companies.

Deep Sea Electronics Ltd reserves the right to change the contents of this document without prior notice.

#### **Amendments since last publication**

<b>Issue. No.</b>	<b>Comments</b>
1	Added Efficiency curve of 2 A charger
2	Updated specs table of 3.7 A charger
3	Added 5 A DSE9255 charger and 9250-002 277 V input charger
7	Added DSE9155 30 V 2 A charger
8	Added 10 A charger
8.1	Added Indication (LED) for 10A chargers
8.2	Added detail regarding -002- chargers asnd cabinet/industrial chargers
9	Added 9400 series
9.1	Corrected specs for 9140
10	Removed all DSE9400 series chargers, added DSE9470
11	Added new DSE9400 series Chargers
12	Changes to add DSE9150 12 V 3 A
13	Updated DSE9470 and DSE9480 to -003 (MKII) and added DSE9472MKII and DSE9481 MKII
14	Typos corrected

Continued overleaf.

Issue No.	Comments
15	Added the DSE9473 and DSE9483 battery chargers
16	Added DSE9476.
17	Corrected DSE9470 / DSE9472 / DSE9480 / DSE9481 voltage descriptions in sections 3.1, 4.2 and 4.3.3. Updated derate curves for DSE9473
18	Added DSEnet and updated the DSE9473, removed DSE9476
19	The Soft Start feature added to the DSE9473
20	Additional descriptions added for the protections
21	The Soft Start feature added to the DSE9483
22	Charge Termination stage added for the DSE9470, DSE9472, DSE9480, DSE9481 supporting the Lithium Phosphate Battery Type
23	Note added to protection regarding fault relay

Typeface : The typeface used in this document is *Arial*. Care should be taken not to mistake the upper case letter I with the numeral 1. The numeral 1 has a top serif to avoid this confusion.

**TABLE OF CONTENTS**

Section	Page
<b>1 BIBLIOGRAPHY.....</b>	<b>6</b>
1.1 INSTALLATION INSTRUCTIONS.....	6
1.2 MANUALS.....	6
<b>2 INTRODUCTION.....</b>	<b>7</b>
<b>3 SPECIFICATIONS.....</b>	<b>8</b>
3.1 COMMON ELECTRICAL SPECIFICATIONS.....	8
3.2 COMMUNICATION PORT USAGE.....	10
3.2.1 USB CONNECTION.....	10
3.2.2 RS485.....	11
3.4 OUTPUT SPECIFICATIONS.....	13
3.4.1 DSE9130 12 V, 5 A.....	13
3.4.2 DSE9140 12 V, 10 A.....	14
3.4.3 DSE9150 12 V, 2 A.....	15
3.4.4 DSE9150 12 V, 3 A.....	16
3.4.5 DSE9155 30 V, 2 A.....	17
3.4.6 DSE9250 24 V, 3.7 A.....	18
3.4.7 DSE9255 24 V, 5 A.....	19
3.4.8 DSE9260 24 V, 10 A.....	20
3.4.9 DSE9470 (MKII) 24 V / 12 V, 10 A.....	21
3.4.10 DSE9472 (MKII) 24 V / 12 V, 5 A.....	23
3.4.11 DSE9473 24 V, 15 A.....	24
3.4.12 DSE9480 (MKII) 12 V / 24 V, 10 A.....	27
3.4.13 DSE9481 (MKII) 12 V / 24 V, 5 A.....	29
3.4.14 DSE9483 12 V, 15 A.....	30
3.5 DIMENSIONS AND MOUNTING.....	32
3.5.1 DSE907 12 V, 10 A INDUSTRIAL BATTERY CHARGER.....	32
3.5.2 DSE908 12 V & 24 V, 10 A CABINET MOUNTED BATTERY CHARGER.....	33
3.5.3 DSE9130 12 V, 5 A.....	34
3.5.4 DSE9150 12 V, 2 A.....	35
3.5.5 DSE9150 12 V, 3 A.....	36
3.5.6 DSE9140 12 V, 10 A.....	37
3.5.7 DSE9155 30 V, 2 A.....	38
3.5.8 DSE9250 24 V, 3.7 A.....	39
3.5.9 DSE9255 24 V, 5 A.....	40
3.5.10 DSE9260 24 V, 10 A.....	41
3.5.11 DSE9470 (MKII) 24 V / 12 V, 10 A.....	42
3.5.12 DSE9472 (MKII) 24 V / 12 V, 5 A.....	43
3.5.13 DSE9473 24 V, 15 A.....	44
3.5.14 DSE9480 (MKII) 12 V / 24 V, 10 A.....	45
3.5.15 DSE9481 (MKII) 12 V / 24 V, 5 A.....	46
3.5.16 DSE9483 12 V, 15 A.....	47
3.6 APPLICABLE STANDARDS.....	48
<b>4 INSTALLATION.....</b>	<b>49</b>
4.1 BATTERY SUITABILITY.....	49
4.2 USER CONNECTIONS.....	49
4.2.1 DSE9130, DSE9140, DSE9250, DSE9255, DSE9260, DSE9701 & DSE9702.....	50
4.2.2 DSE9150.....	50
4.2.3 DSE9155.....	51
4.2.4 DSE9470 MKII, DSE9472 MKII, DSE9480 MKII & DSE9481 MKII.....	52
4.2.5 DSE9473 & DSE9483.....	54
4.3 TYPICAL WIRING DIAGRAM.....	56
4.3.1 DSE9150.....	56
4.3.2 DSE9155 & DSE9200 SERIES.....	57
4.3.3 DSE9470 MKII, DSE9472 MKII, DSE9480 MKII & DSE9481 MKII.....	58

4.3.4	DSE9473 & DSE9483.....	59
<b>5</b>	<b>INDICATIONS.....</b>	<b>60</b>
5.1	DSE907.....	60
5.2	DSE908.....	60
5.3	DSE9130, DSE9150, DSE9155, DSE9250 & DSE9255.....	61
5.4	DSE9140 & DSE9260.....	62
5.5	DSE9470 MKII, DSE9472 MKII, DSE9480 MKII & DSE9481 MKII.....	63
5.5.1	STATUS.....	63
5.5.2	CHARGE MODE.....	63
5.5.3	FAULT CONDITIONS.....	63
<b>6</b>	<b>OPERATION.....</b>	<b>64</b>
6.1	OPERATION OF DSE9100 SERIES & DSE9200 SERIES.....	64
6.1.1	PROTECTION.....	64
6.1.2	PSU MODE.....	64
6.1.3	CHARGE MODE.....	64
6.1.4	BOOST MODE.....	65
6.2	OPERATION OF DSE9470 MKII, DSE9472 MKII, DSE9473, DSE9480 MKII, DSE9481 MKII & DSE9483.....	66
6.2.1	PROTECTION.....	66
6.2.2	DIGITAL INPUT.....	68
6.2.3	VOLTAGE ADJUSTMENT POTENTIOMETER.....	68
6.2.4	PSU MODE.....	68
6.2.5	CHARGE MODE.....	69
6.2.6	TEMPERATURE COMPENSATION.....	71
<b>7</b>	<b>FAULT DIAGNOSIS.....</b>	<b>72</b>
<b>8</b>	<b>MAINTENANCE, SPARES, REPAIR AND SERVICING.....</b>	<b>73</b>
<b>9</b>	<b>WARRANTY.....</b>	<b>73</b>
<b>10</b>	<b>DISPOSAL.....</b>	<b>73</b>
10.1	WEEE (WASTE ELECTRICAL AND ELECTRONIC EQUIPMENT).....	73

# 1 BIBLIOGRAPHY

This document refers to and is referred to by the following DSE publications which can be obtained from the DSE website [www.deepseaelectronics.com](http://www.deepseaelectronics.com)

## 1.1 INSTALLATION INSTRUCTIONS

Installation instructions are supplied with the product in the box and are intended as a 'quick start' guide only.

DSE PART	DESCRIPTION
053-049	DSE9200 / DSE9400 Series Battery Charger Installation Instructions
053-123	DSE9150 Battery Charger Installation Instructions

## 1.2 MANUALS

DSE PART	DESCRIPTION
057-159	DSE9400 Series Battery Charger Configuration Suite Manual

## 2 INTRODUCTION

 **NOTE: This document DOES NOT contain details of the 'obsolete' DSE9210 and DSE9240 battery chargers. For further details of these units, please contact Deep Sea Electronics.**

This document details the installation requirements of the DSE9xx, 91xx, 92xx & 94xx series range of battery chargers.

The manual forms part of the product and should be kept for the entire life of the product. If the product is passed or supplied to another party, ensure that this document is passed to them for reference purposes.

This is not a *controlled document*. You will not be automatically informed of updates. Any future updates of this document will be added to the DSE website at [www.deepseaelectronics.com](http://www.deepseaelectronics.com).

The DSE9000 series modules are intended for mounting within a customer enclosure or panel (DIN rail mounting or fastened by screws/bolts).

DSE also supply some of the battery chargers as completed units, factory mounted into enclosures for wall or floor mounting.

The DSE9000 series chargers fulfill the most common functions required of a charger in the generating set industry. Combining protected outputs, intelligent charging and power supply operation with a robust enclosure.

### 3 SPECIFICATIONS

#### 3.1 COMMON ELECTRICAL SPECIFICATIONS

Parameter		Min	Nominal	Max
<b>AC Input Voltage (V)</b>				
DSE9130 12 V 5 A		90 V	110 V-277 V	304 V
DSE9150 12 V 2 A		90 V	110 V-240 V	250 V
DSE9150 12 V 3 A		90 V	110 V-240 V	265 V
DSE9140 12 V 10 A		90 V	110 V-240 V	277 V
DSE9155 30 V 2 A		85 V	110 V-240 V	265 V
DSE9250 24 V 3.7 A (9250-001-xx)		90 V	110 V-240 V	265 V
DSE9250 24 V 3.7 A (9250-002-xx)		90 V	110 V-277 V	305 V
DSE9255 24 V 5 A		90 V	110 V-277 V	305 V
DSE9260 24 V 10 A		90 V	110 V-277 V	305 V
DSE9470 24 V / 12 V 10 A		95 V	110 V-277 V	305 V
DSE9472 24 V / 12 V 5 A		95 V	110 V-277 V	305 V
DSE9473 24 V 15 A		95 V	110 V-277 V	305 V
DSE9480 12 V / 24 V 10 A		90 V	110 V-277 V	305 V
DSE9481 12 V / 24 V 5 A		95 V	110 V-277 V	305 V
DSE9483 12 V 15 A		95 V	110 V-277 V	305 V
<b>Operating Temperature</b>	DSE9100 Series	-30 °C		55 °C
	DSE9200 Series	-30 °C		55 °C
	DSE9400 Series	-30 °C		75 °C with de-ratings
<b>Input Frequency (Hz)</b>		48 Hz		64 Hz
<b>Output Ripple and Noise</b>	DSE9100 Series		1% Vo	
	DSE9200 Series		2% Vo	
	DSE9400 Series		1% Vo	
<b>Load Regulation</b>	DSE9100 Series		1% Vo	
	DSE9200 Series		2% Vo	
	DSE9400 Series		1% Vo	
<b>Line Regulation</b>			<0.01% Vo	
<b>Output Voltage Overshoot %</b>			<5%Vo	
<b>Transient Response Peak Deviation (mV)</b> (at 50% to 100% load step)			<4% Vo	
<b>Warm Up Voltage (V)</b>			<1% Vo	
<b>Output Voltage Rise Time (ms)</b>	DSE9100 Series		<100 ms	
	DSE9200 Series		<100 ms	
	DSE9400 Series		<200 ms	
<b>Short Circuit Protection</b>			Hiccup	
<b>Switching Frequency (kHz)</b>				
9130-001-xx (replaced with 9130-002-xx)			100 kHz	
9250-001-xx (replaced with 9250-002-xx)			100 kHz	
9130-002-xx			67 kHz	
9250-002-xx			67 kHz	
9470-xxx-xx			67 kHz	
9472-xxx-xx			67 kHz	
9473-xxx-xx			60KHz	
9480-xxx-xx			67KHz	
9481-xxx-xx			67 kHz	
9483-xxx-xx			60KHz	
9255			65 kHz	
All other chargers			100 kHz	

Continued overleaf



*Specifications*

Parameter		Min	Nominal	Max
<b>Efficiency %</b> (See section entitled 'output specifications' elsewhere in this manual)	DSE9100 Series DSE9200 Series		>80%	
	DSE9400 Series DSE9473 DSE9474		>85% >90% >90%	
<b>Temperature Sensor Input</b>	DSE9400 Series		PT1000	

 **NOTE: Check the DSE9400 Series de-rating curves that can be found elsewhere in this manual for more information.**

### 3.2 COMMUNICATION PORT USAGE

Communication	Specification
<b>USB Port</b> (DSE9400 series only)	USB2.0 Device for connection to PC running DSE Configuration Suite Max distance 6 m (20 feet)
<b>RS485 Serial Port</b> (DSE9400 series only)	Isolated Data connection 2 wire + common Half Duplex Data direction control for Transmit (by s/w protocol) Max Baud Rate 19200 External termination required (120 Ω) Max common mode offset 70 V (on board protection transorb) Max distance 1.2 km (¾ mile)

#### 3.2.1 USB CONNECTION

The USB port is provided to give a simple means of connection between a PC and the DSE9400 series battery charger. Using the DSE Configuration Suite Software, the operator is then configure and monitor the state of the battery charger.

To connect a DSE9400 series battery charger to a PC by USB, the following items are required:

- DSE9400 series battery charger
- DSE Configuration Suite Software  
(Supplied on configuration suite software CD or available from [www.deepseaelectronics.com](http://www.deepseaelectronics.com)).
- USB cable Type A to Type B.  
(This is the same cable as often used between a PC and a USB printer)



DSE can supply this cable if required :  
PC Configuration interface lead (USB type A – type B) DSE Part No 016-125

**NOTE:** - Refer to DSE9400 Series Battery Charger PC Software Configuration Manual for further details on configuring and monitoring.

### 3.2.2 RS485

The RS485 port on the DSE9400 series battery chargers has three uses.

- 1) Supporting the DSE2541 remote battery charger display module (MKII only)
- 2) Support the Modbus RTU protocol for connection to a Modbus RTU Master device.
- 3) Supporting the DSENet® connection with the supported modules.

#### 3.2.2.1 DSE2541 REMOTE BATTERY CHARGER DISPLAY MODULE

DSE2541 remote battery charger display modules connects to the DSE9400 MKII Series battery charger RS485 terminals.

This provides battery charger operating status, alarm indication, instrumentation and control over the DSE9400 MKII Series battery charger.

For further information please contact [sales@deepseaelectronics.com](mailto:sales@deepseaelectronics.com).



#### 3.2.2.2 MODBUS RTU

RS485 is used for point-to-point cable connection of more than one device (maximum 32 devices) and allows for connection to PCs, PLCs and Building Management Systems (to name just a few devices).

Using the DSE Configuration Suite PC Software, Configurable Gencomm is used to map instrumentation to modbus registers.

One advantage of the RS485 interface is the large distance specification (1.2 km) when using Belden 9841 (or equivalent) cable. This allows for a large distance between the DSE9400 series battery charger and a PC running the DSE Configuration Suite software. The operator is then able to view the various operating parameters.

**NOTE: For distances up to 6 m (8 yds) the USB connection method is more suitable and provides for a lower cost alternative to RS485 (which is more suited to longer distance connections).**

#### 3.2.2.3 DSENET

The DSE Intelligent Battery Chargers RS485 port can be configured as DSENet® using the DSE Configuration Suite PC Software to allow the DSE Intelligent Battery Chargers' information (Instruments and Status) to be viewed on the Genset controller's display.

At the time of writing this manual, the following DSE Intelligent Battery Chargers support the DSENet® communication on their RS485 port:  
DSE9460, DSE9461, DSE9470 MKII, DSE9472 MKII, DSE9473, DSE9476, DSE9480 MKII, DSE9481 MKII, DSE9483, DSE9484.

**NOTE: You should contact DSE Technical Support for any updates or additional information at [Support@deepseaelectronics.com](mailto:Support@deepseaelectronics.com).**

### 3.2.2.4 OPTIONS FOR CONNECTION TO PCS

- Brainboxes PM154 PCMCIA RS485 card (for laptops PCs)  
Set to 'Half Duplex, Autogating" with 'CTS True' set to 'enabled'
- Brainboxes VX-023 ExpressCard 1 Port RS422/485 (for laptops and nettop PCs)
- Brainboxes UC320 PCI Velocity RS485 card (for desktop PCs)  
Set to 'Half Duplex, Autogating" with 'CTS True' set to 'enabled'
- Brainboxes PX-324 PCI Express 1 Port RS422/485 (for desktop PCs)



Supplier:

**Brainboxes**

**Tel:** +44 (0)151 220 2500

**Web:** <http://www.brainboxes.com>

**Email:** Sales: [sales@brainboxes.com](mailto:sales@brainboxes.com)

### 3.4 OUTPUT SPECIFICATIONS

#### 3.4.1 DSE9130 12 V, 5 A

Parameter	Min	Nominal	Max	Comments
Output Voltage (12 V DC battery)	12.5 V	13.7 V	15.0 V	Specify float voltage on ordering.
Output Charging Current (A)	0 A	5 A	5.5 A	
Current limit threshold (A)	5 A	5.3 A	5.5 A	
Recovery from current limit (A)	5 A			
Full load AC input current (A)		1.5 A		With output at 13.7 V DC
AC Input Inrush current (A)		20 A		For 10 ms

**DSE9130 Efficiency Curve at 5 A**

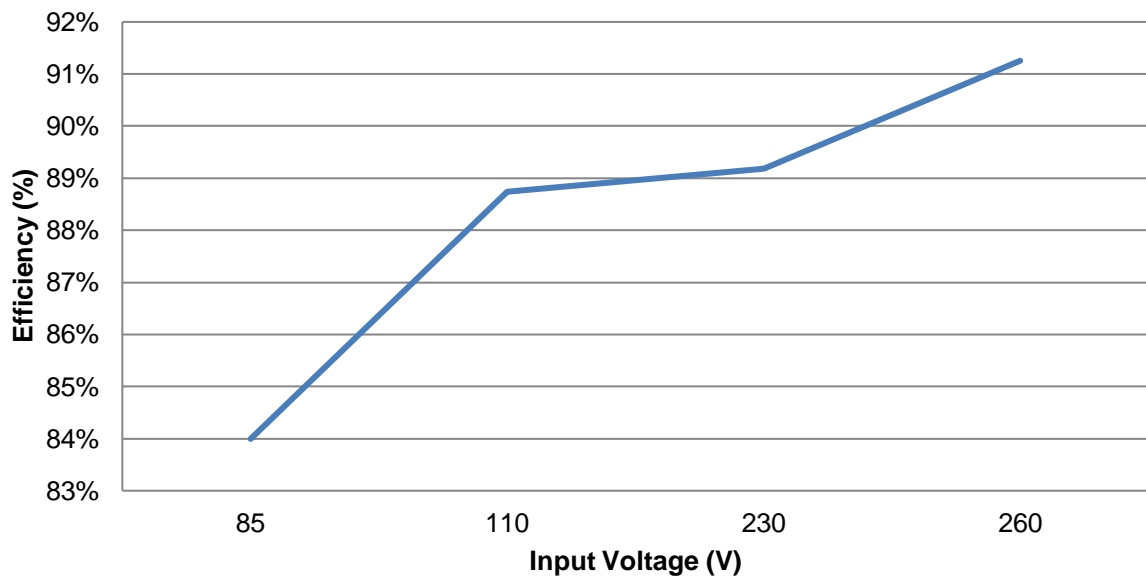

**3.4.2 DSE9140 12 V, 10 A**

Parameter	Min	Nominal	Max	Comments
Output Voltage (12 V DC Battery)	12 V	13.7 V	15 V	
Output Charging Current (A)	10 A	10 A	11 A	
Current limit threshold (A)	10 A		11 A	
Recovery from current limit (A)	10 A		11 A	
Full load AC input current (A)		3.1 A		At Vin=85 V, Vo=13.7 V, Io=10 A
Full load AC input current (A)		1.3 A		At Vin=230 V, Vo=13.7 V Io=10 A
AC Input Inrush current (A)		60 A		For 10 ms

**DSE9140 Efficiency Curve at 10 A**

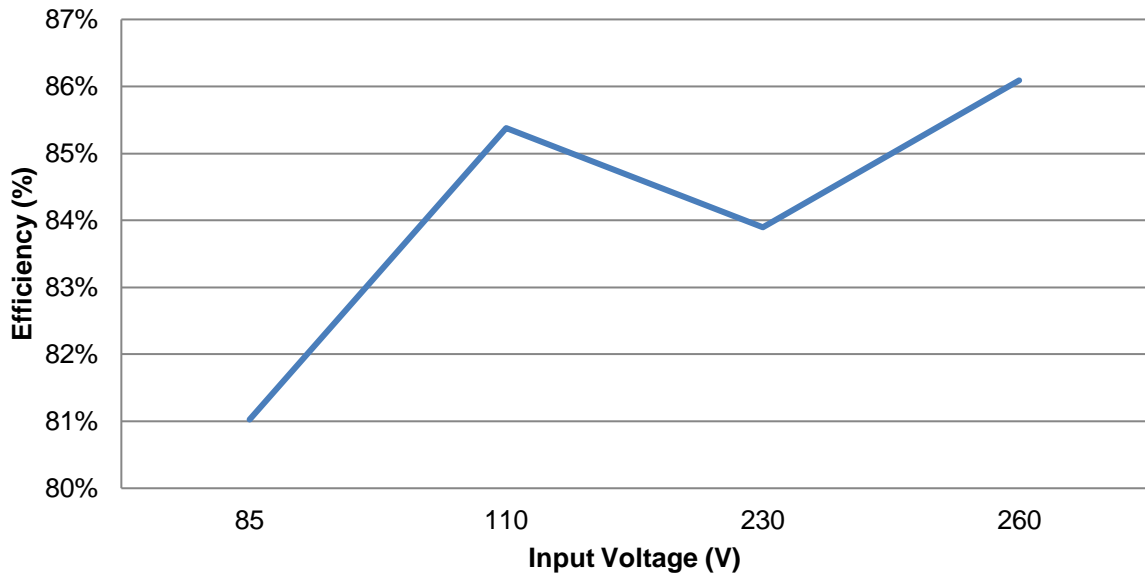

3.4.3 DSE9150 12 V, 2 A

**NOTE:** This device is no longer available, replaced by DSE9150 12 V 3 A. See overleaf for updated specifications.

Parameter	Min	Nominal	Max	Comments
Output Voltage (12 V DC Battery)	12.5 V	13.7 V	13.7 V	Float voltage not adjustable
Output Charging Current (A)	0 A	2 A	2.5 A	
Current limit threshold (A)	2 A	2.3 A	2.5 A	
Recovery from current limit (A)	2 A			
Full load AC input current (A)		0.7 A		With output at 13.7 V DC
AC Input Inrush current (A)		10 A		For 10 ms

**DSE9150 Efficiency Curve at 2 A**

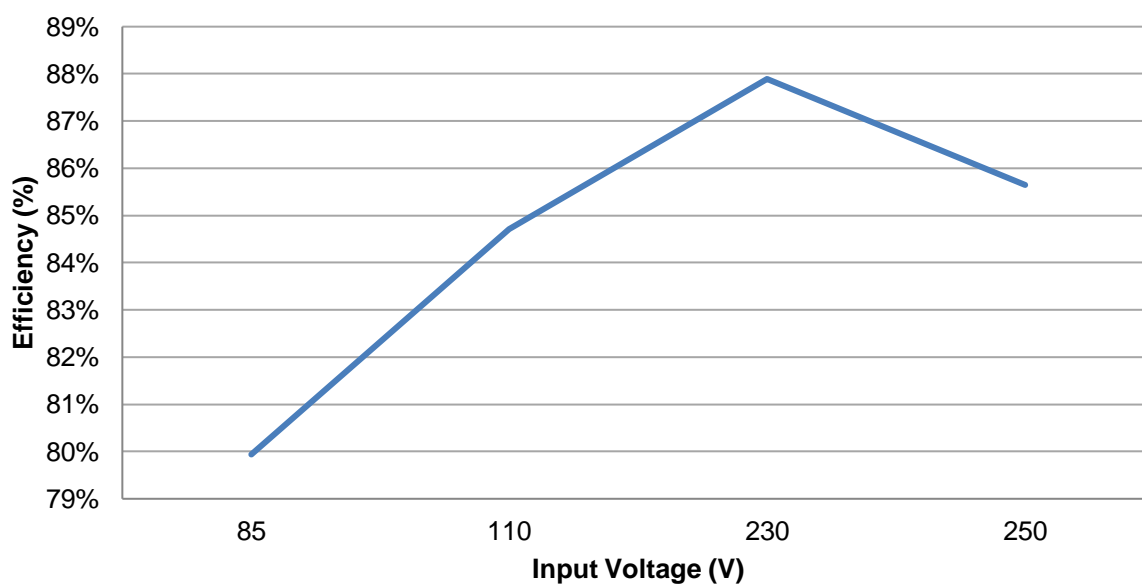

3.4.4 DSE9150 12 V, 3 A

**▲ NOTE:** This device has replaced DSE9150 12 V 2 A. See previous page for specifications of the earlier model.

Parameter	Min	Nominal	Max	Comments
Output Voltage (12 V DC Battery)	12.5 V	13.7 V	13.7 V	Float voltage not adjustable
Output Charging Current (A)	0 A	3 A	3.5 A	
Current limit threshold (A)	3 A	3.2 A	3.5 A	
Recovery from current limit (A)	3 A			
Full load AC input current (A)		0.7 A		With output at 13.7 V DC
AC Input Inrush current (A)		10 A		For 10 ms

**DSE9153 Efficiency Curve at 3 A**

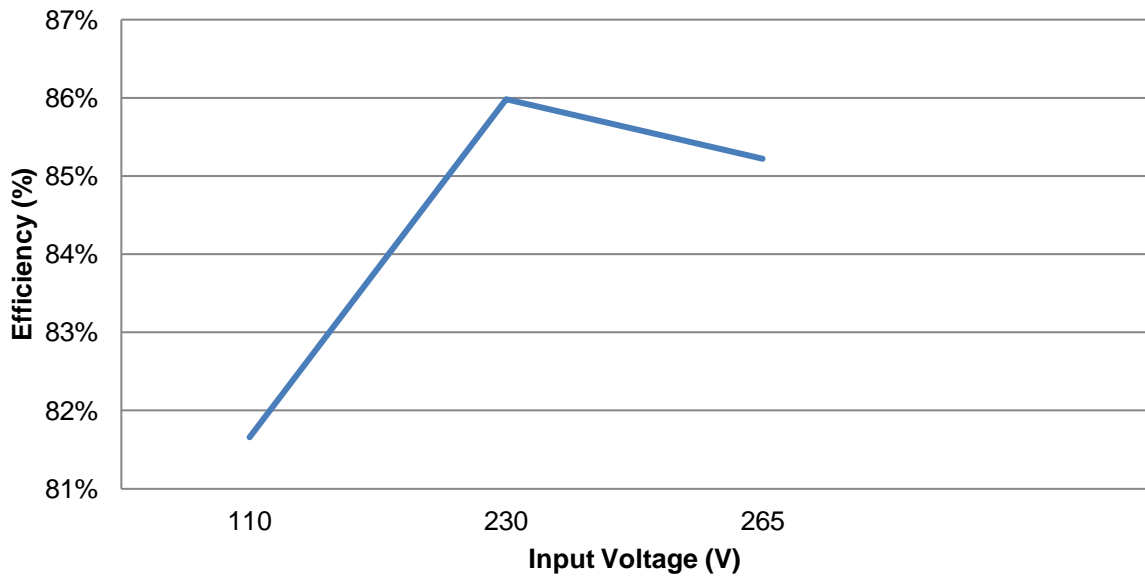



**3.4.5 DSE9155 30 V, 2 A**

Parameter	Min	Nominal	Max	Comments
Output Voltage (30 V DC Battery)	28.0 V	34.3 V	34.5 V	
Output Charging Current (A)	0 A	2.2 A	3 A	
Current limit threshold (A)	2 A	2.2 A	3 A	
Recovery from current limit (A)	2 A			
Full load AC input current (A)			2 A	
AC Input Inrush current (A)		30 A		

**DSE9155 Efficiency Curve at 2 A**

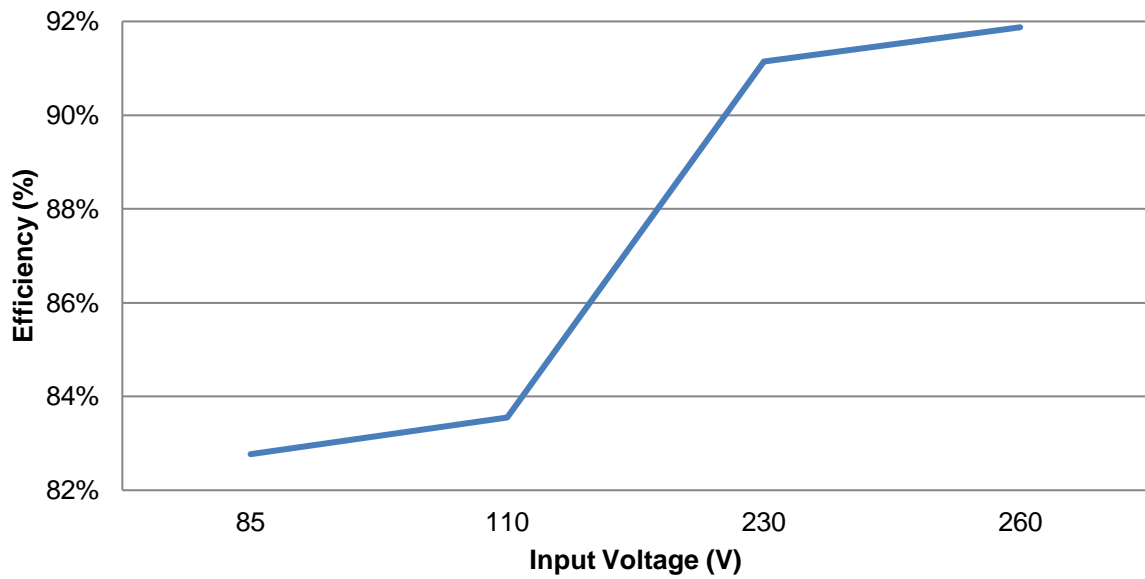

3.4.6 DSE9250 24 V, 3.7 A

**NOTE:** - This battery charger is now obsolete, details provided for information only.

Parameter	Min	Nominal	Max	Comments
Output Voltage (24 V DC Battery)	25.0 V	27.4 V	30.0 V	Specify float voltage on ordering.
Output Charging Current (A)	0 A	3.7 A	4 A	
Current limit threshold (A)	3.6 A	3.75 A	4 A	
Recovery from current limit (A)	3.6 A			
Full load AC input current (A)		2 A		With output at 27.6 V DC
AC Input Inrush current (A)		30 A		For 10 ms

**DSE9250 Efficiency Curve at 3.7 A**

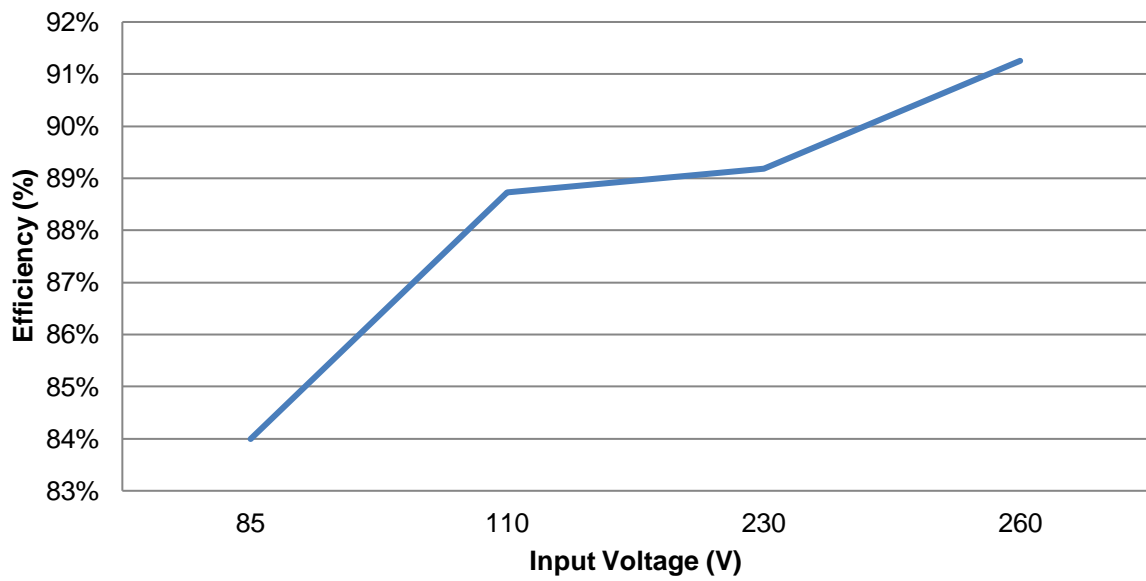

**3.4.7 DSE9255 24 V, 5 A**

Parameter	Min	Nominal	Max	Comments
Output Voltage (24 V DC Battery)	25.0 V	27.4 V	30.0 V	Specify float voltage on ordering.
Output Charging Current (A)	0 A	5 A		
Current limit threshold (A)	5 A	5.3 A	6 A	Derates above 70 °C
Recovery from current limit (A)	5 A	5.2 A		
Full load AC input current (A)	0.65 A		2.7 A	With output at 27.6 V DC
AC Input Inrush current (A)		30 A		For 10 ms

**DSE9255 Efficiency Curve at 5 A**

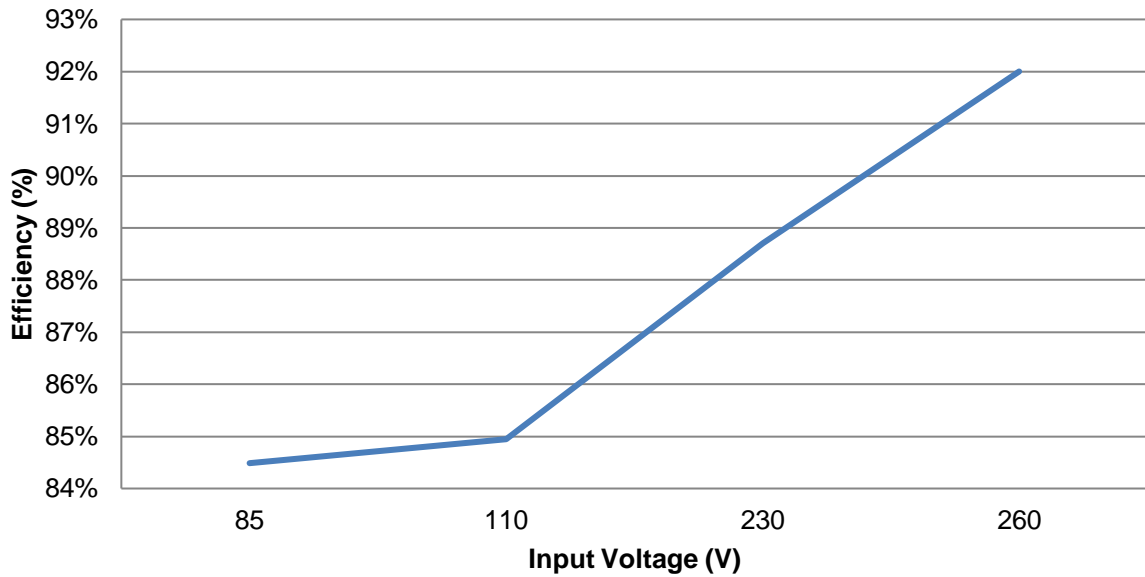

**DSE9255 Temperature Derate Curve**

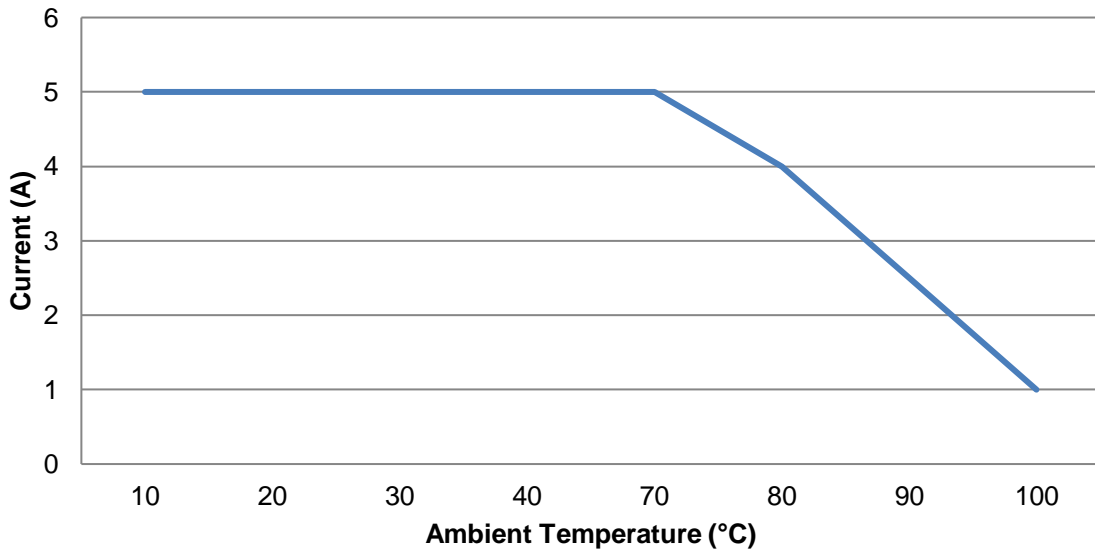

**3.4.8 DSE9260 24 V, 10 A**

Parameter	Min	Nominal	Max	Comments
Output Voltage (24 V DC Battery)	26 V	27.6 V	29 V	
Output Charging Current (A)		10 A	11 A	
Current limit threshold (A)		10 A	11 A	
Recovery from current limit (A)	9.5 A	10 A	11 A	
Full load AC input current (A)			2.2 A	At Vin=230 V, Vo=27.6 V, Io=10 A
Full load AC input current (A)			5.8 A	At Vin=85 V, Vo=27.6 V, Io=10 A
AC Input Inrush current (A)		60 A		For 10ms

**DSE9260 Efficiency Curve at 10 A**

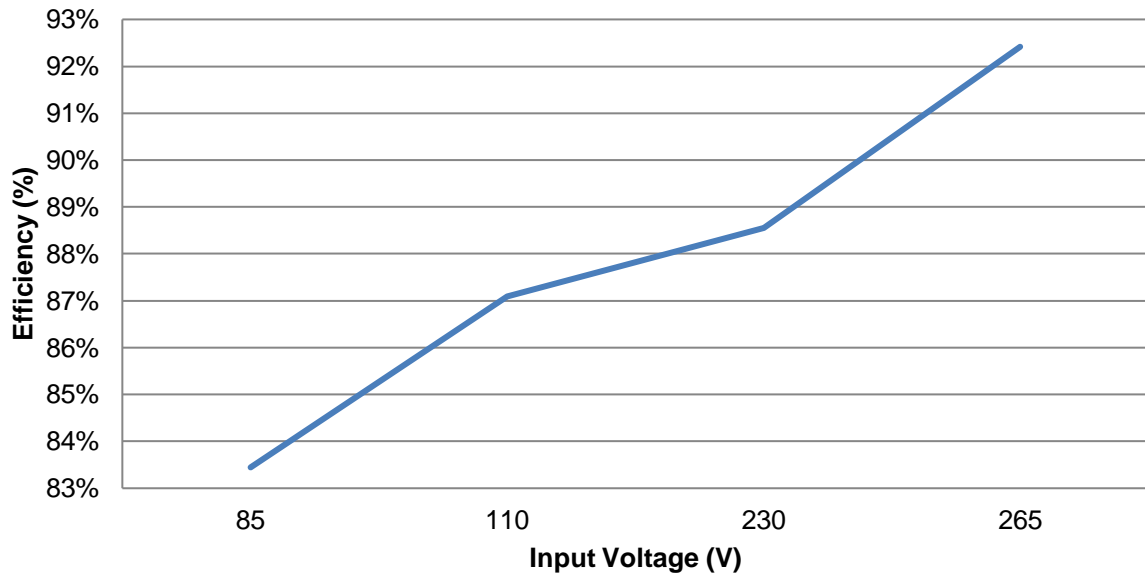

**3.4.9 DSE9470 (MKII) 24 V / 12 V, 10 A**

**▲ NOTE:** DSE9470 is factory configured to 24 V 10 A. If required, voltage and current levels can be user configured via DSE Configuration Suite PC Software.  
 Part number 9470-001-00 is fixed at 24 V 10 A.

Parameter	Min	Nominal	Max	Comments
Output Voltage (24 V DC Battery)	26.7 V	27 V	29 V	
Output Charging Current (A)	2 A	10 A	11 A	
Current limit threshold (A)		10 A	11 A	
Recovery from current limit (A)	10 A		11 A	
Full load AC input current (A)			2.3 A	At Vin=230 V, Vo=28.8 V, Io=10 A
Full load AC input current (A)			4 A	At Vin=110 V, Vo=28.8 V, Io=10 A
AC Input Inrush current (A)		60 A		For 10 ms

**DSE9470 (MKII) Efficiency Curve at 10 A**

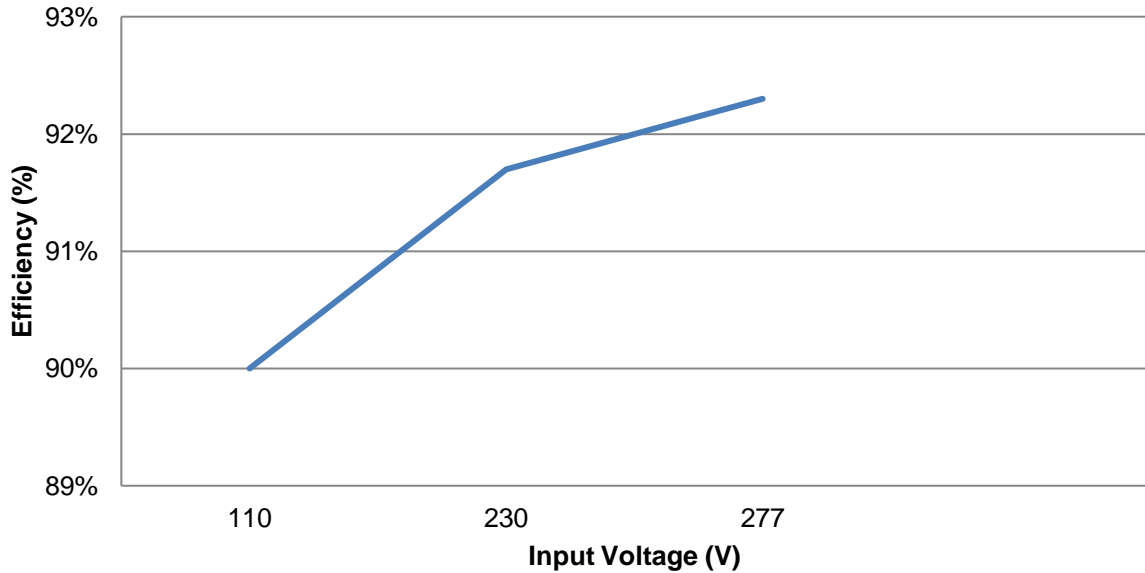

**DSE9470 (MKII) Temperature Derate Curve  
110 V < Vin < 305 V**

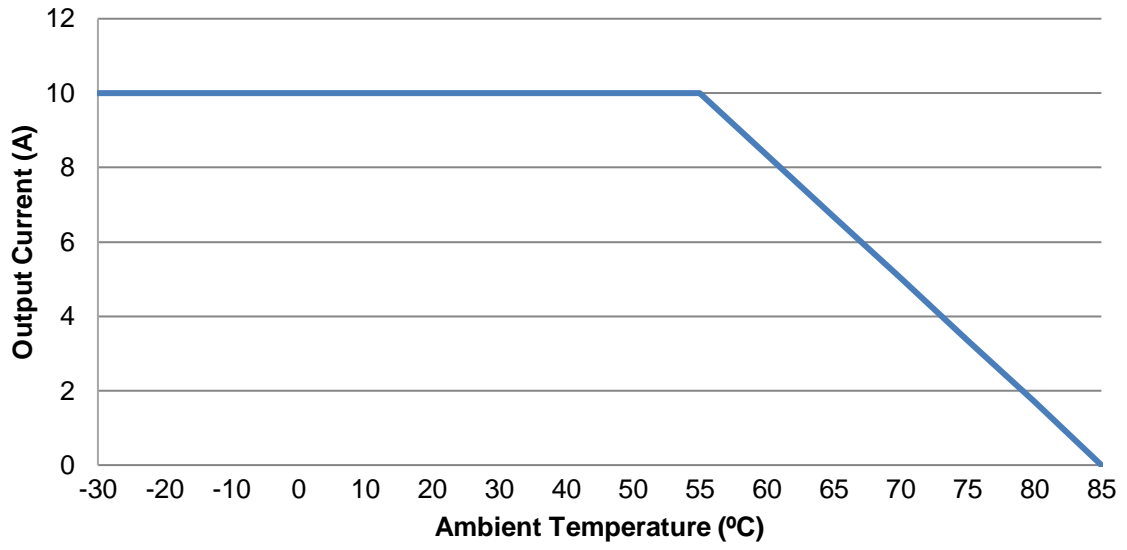

**DSE9470 (MKII) Temperature Derate Curve  
95 V < Vin < 110 V**

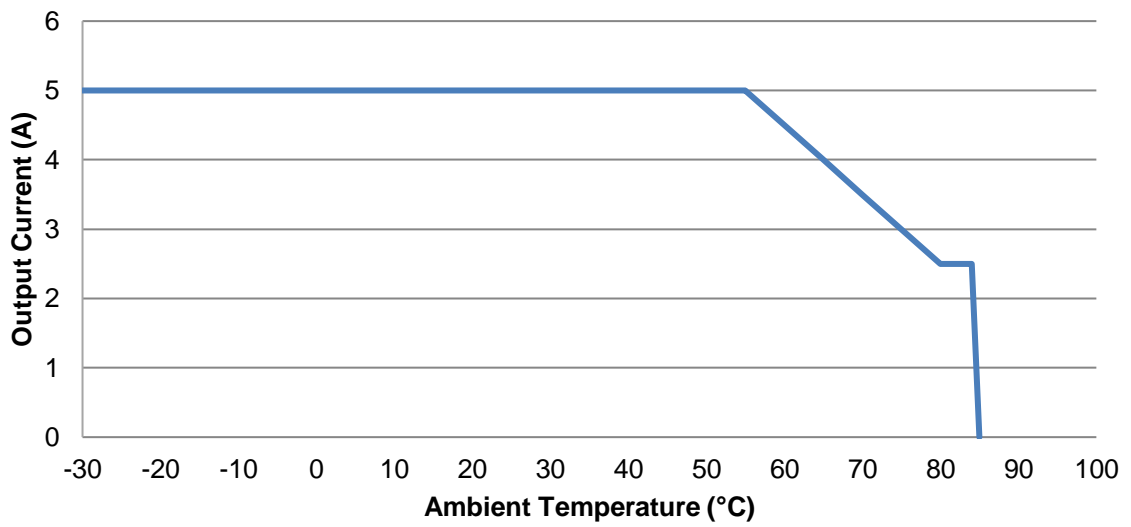

**3.4.10 DSE9472 (MKII) 24 V / 12 V, 5 A**

Parameter	Min	Nominal	Max	Comments
Output Voltage (24 V DC Battery)	26.7 V	27 V	29 V	
Output Charging Current (A)	2 A	5 A	5.5 A	
Current limit threshold (A)		5 A	5.5 A	
Recovery from current limit (A)		5 A		
Full load AC input current (A)			0.5 A	At Vin=230 V, Vo=14.4 V, Io=5A
Full load AC input current (A)			1.1 A	At Vin=110 V, Vo=14.4 V, Io=5 A
AC Input Inrush current (A)		60 A		For 10 ms

**DSE9472 (MKII) Efficiency Curve at 5 A**

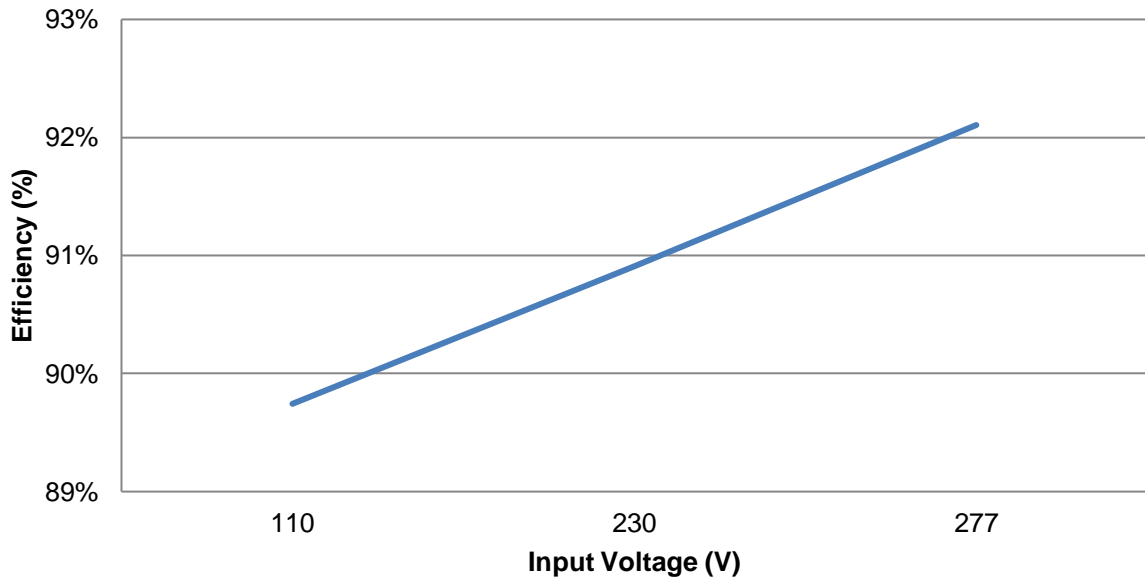

**DSE9472 (MKII) Temperature Derate Curve  
90 V < Vin < 305 V**

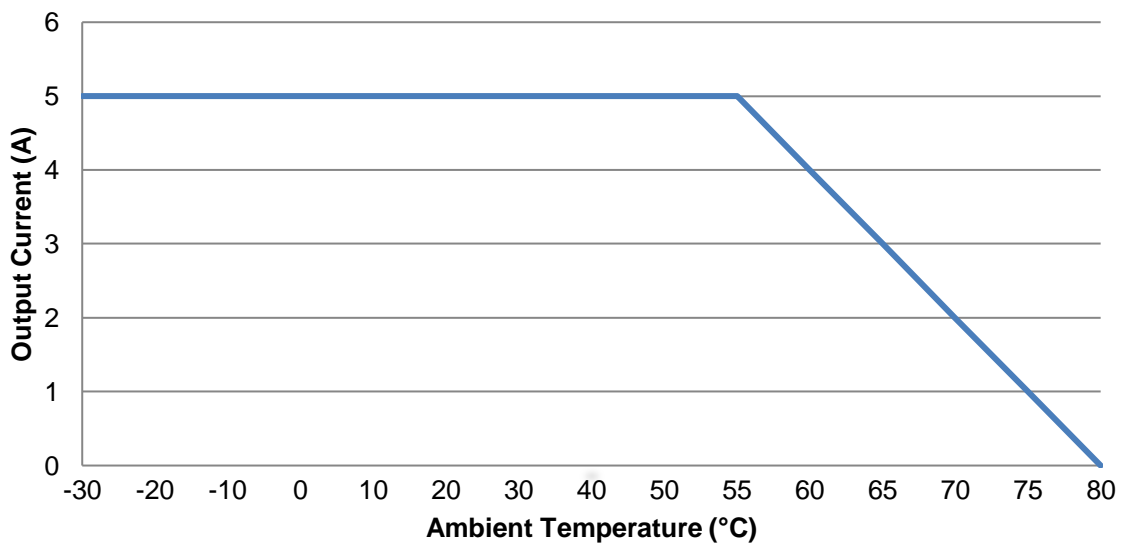

3.4.11 DSE9473 24 V, 15 A

**NOTE:** DSE9473 is fixed to 24 V 15 A. If required, voltage and current levels can be user configured via DSE Configuration Suite PC Software.

**NOTE:** DSE9473 operates in *Soft Start* when enabled using the DSE Configuration Suite PC Software. For further information on the *Soft Start* feature, refer to *DSE Publication: 057-159 DSE9400 Series Battery Charger Configuration Suite Manual*.

Parameter	Min	Nominal	Max	Comments
Output Voltage (24 V DC Battery)	25 V	27 V	29.5 V	
Output Charging Current (A)	3 A	15 A	16 A	
Current limit threshold (A)		15 A	16 A	
Recovery from current limit (A)	15 A		16 A	
Full load AC input current (A)			2.3 A	At Vin=230 V, Vo=28.8 V, Io=15 A
Full load AC input current (A)			4 A	At Vin=110 V, Vo=28.8 V, Io=15 A
AC Input Inrush current (A)		60 A		For 10 ms , 230 V AC Input

**DSE9473 Efficiency Curve at 15 A**

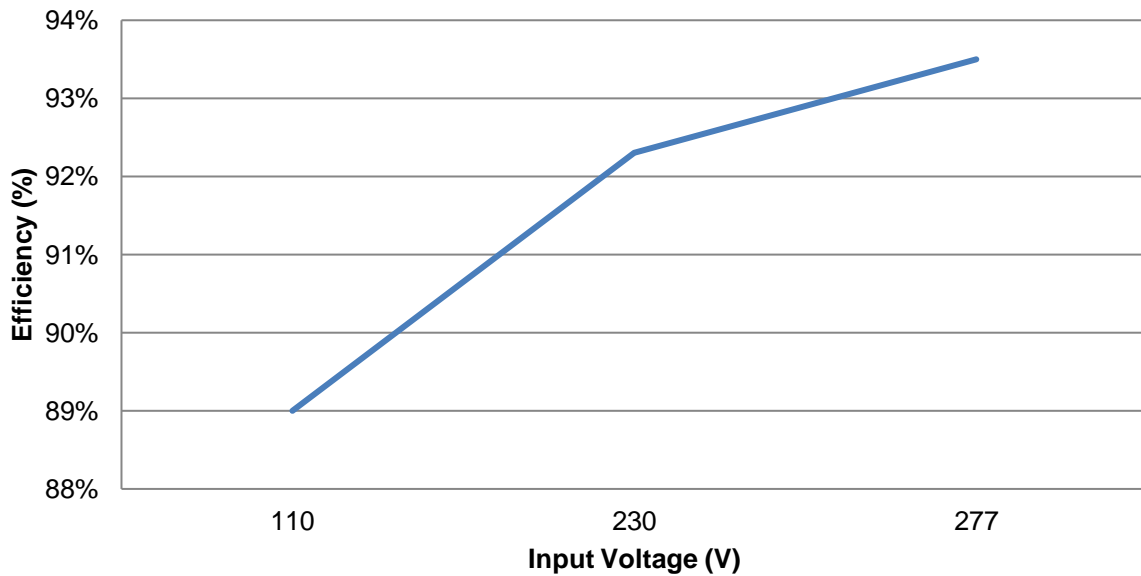



**NOTE:** The following graphs apply to the hardware variants 9473-003-xx and onwards. Contact DSE Technical Support for specifications of previous variants at [Support@deepseaelectronics.com](mailto:Support@deepseaelectronics.com).

**DSE9473 Temperature Derate Curve  
90 V < Vin < 110 V and Ambient < 50 °C**

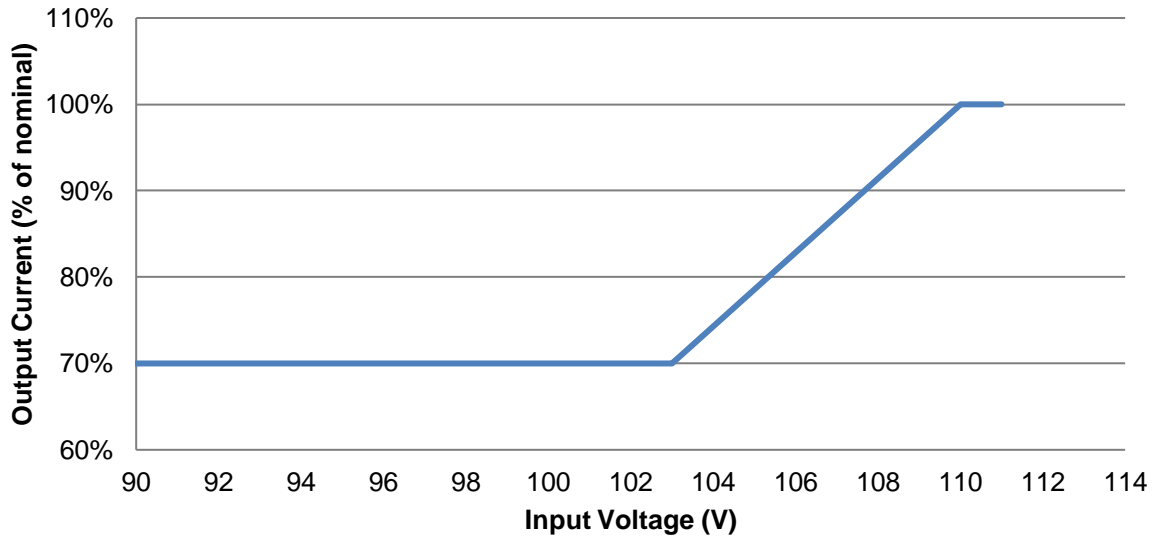

**DSE9473 Temperature Derate Curve  
90 V < Vin < 110 V and Ambient >= 50 °C**

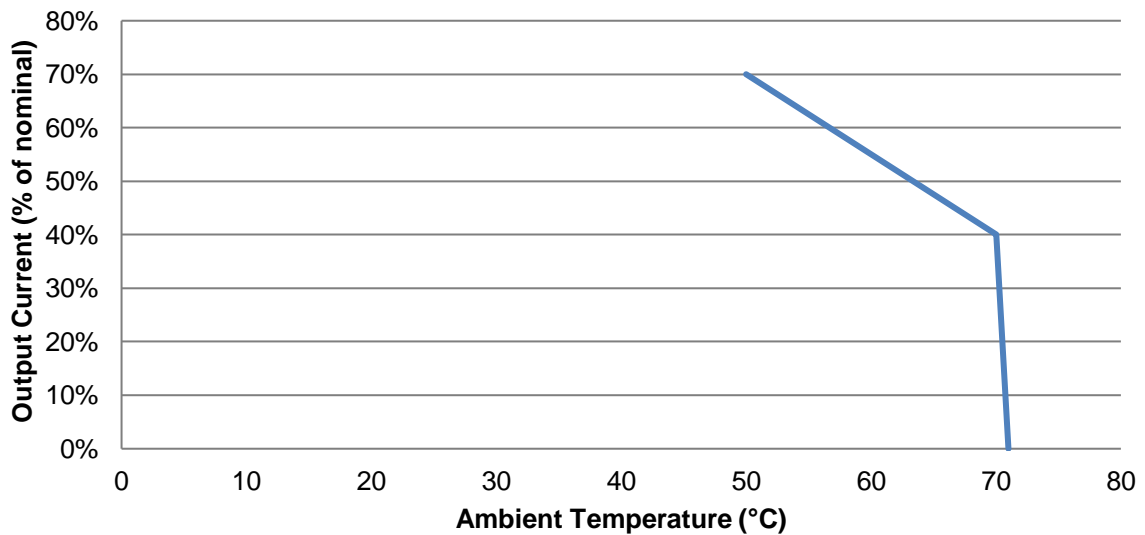

**DSE9473 Temperature Derate Curve**  
**110 V < Vin < 305 V**

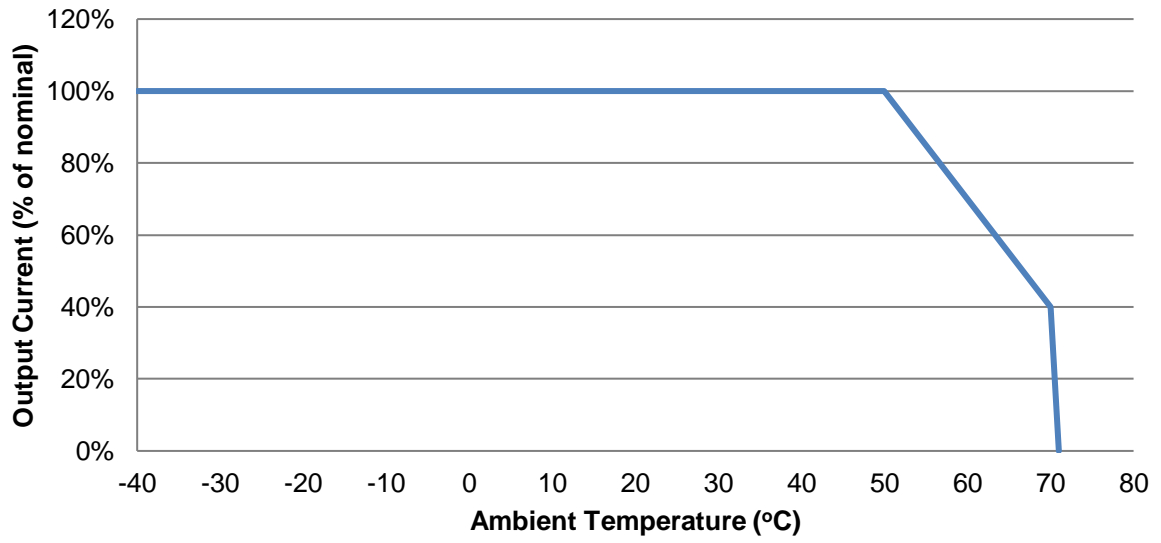

3.4.12 DSE9480 (MKII) 12 V / 24 V, 10 A

**NOTE:** DSE9480 is factory configured to 12 V 10 A. If required, voltage and current levels can be user configured via DSE Configuration Suite PC Software.  
Part number 9480-001-00 is fixed at 12 V 10 A.

Parameter	Min	Nominal	Max	Comments
Output Voltage (12 V DC Battery)	13.4 V	13.5 V	14.5 V	
Output Charging Current (A)	2 A	10 A	11 A	
Current limit threshold (A)		10 A	11 A	
Recovery from current limit (A)	10 A		11 A	
Full load AC input current (A)			1.2 A	At Vin=230 V, Vo=14.4 V, Io=10 A
Full load AC input current (A)			2.2 A	At Vin=110 V, Vo=14.4 V, Io=10 A
AC Input Inrush current (A)		60 A		For 10 ms

**DSE9480 (MKII) Efficiency Curve at 10 A**

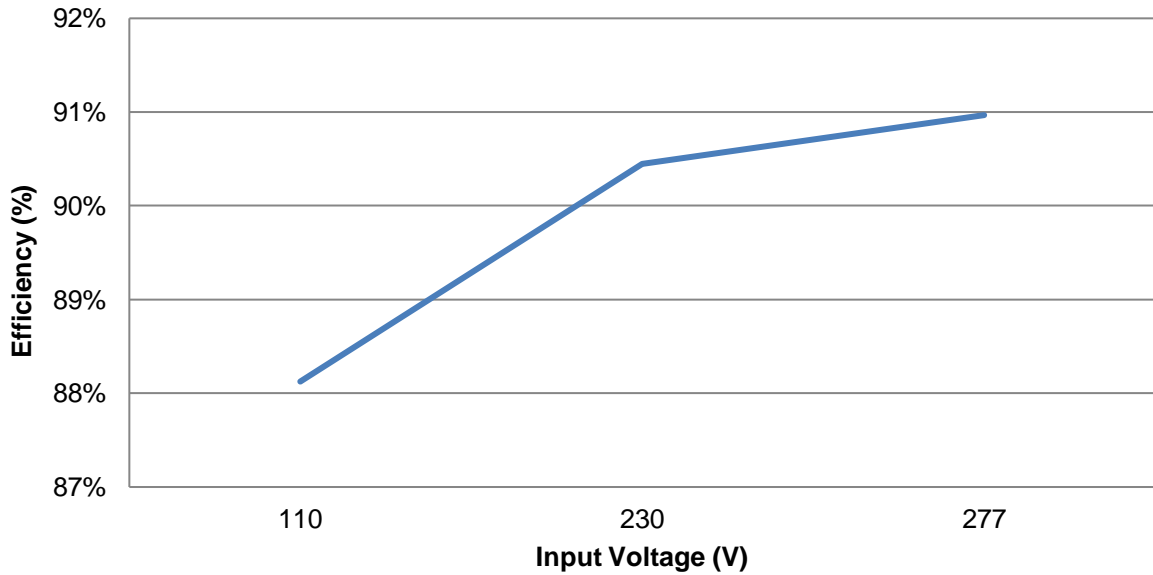

**DSE9480 (MKII) Temperature Derate Curve  
110 V < Vin < 305 V**

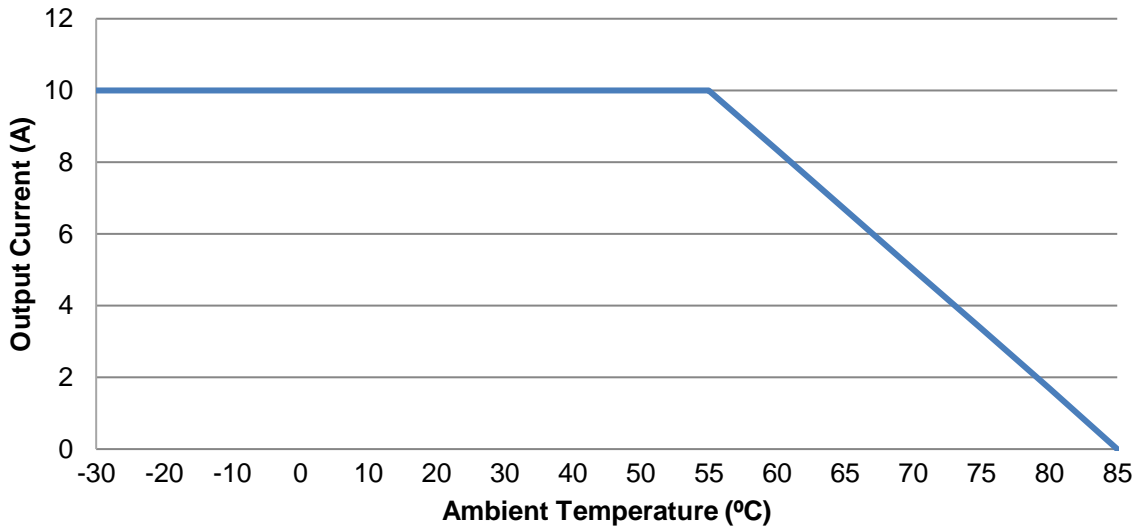

**DSE9480 (MKII) Temperature Derate Curve  
95 V < Vin < 110 V**

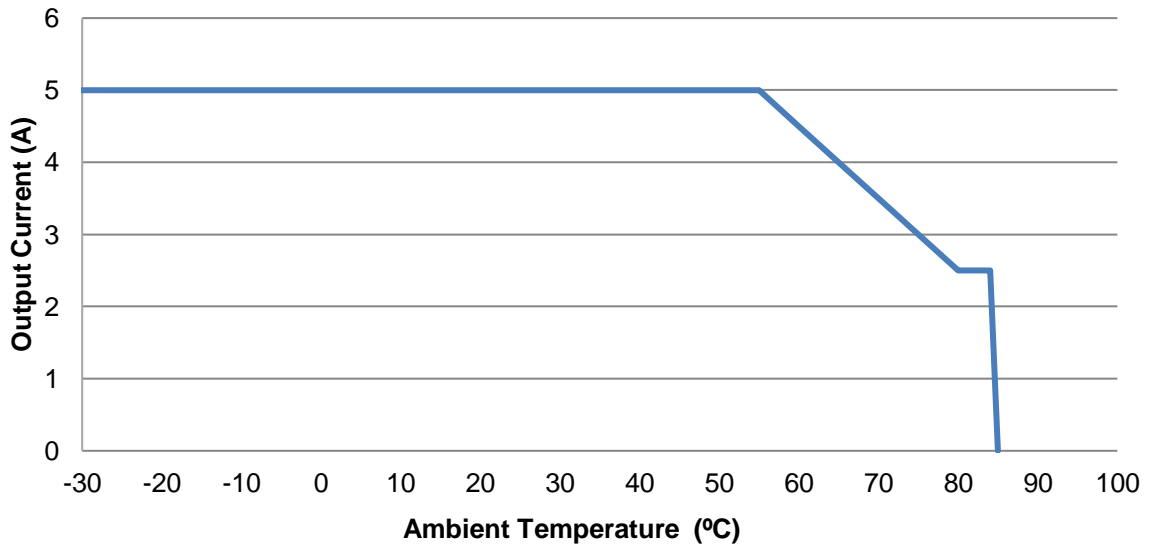

**3.4.13 DSE9481 (MKII) 12 V / 24 V, 5 A**

Parameter	Min	Nominal	Max	Comments
Output Voltage (12 V DC Battery)	13.4 V	13.5 V	14.5 V	
Output Charging Current (A)	2 A	5 A	5.5 A	
Current limit threshold (A)		5 A	5.5 A	
Recovery from current limit (A)		5 A		
Full load AC input current (A)			0.5 A	At Vin=230 V, Vo=14.4 V, Io=5A
Full load AC input current (A)			1.1 A	At Vin=110 V, Vo=14.4 V, Io=5 A
AC Input Inrush current (A)		60 A		For 10 ms

**DSE9481 (MKII) Efficiency Curve at 5 A**

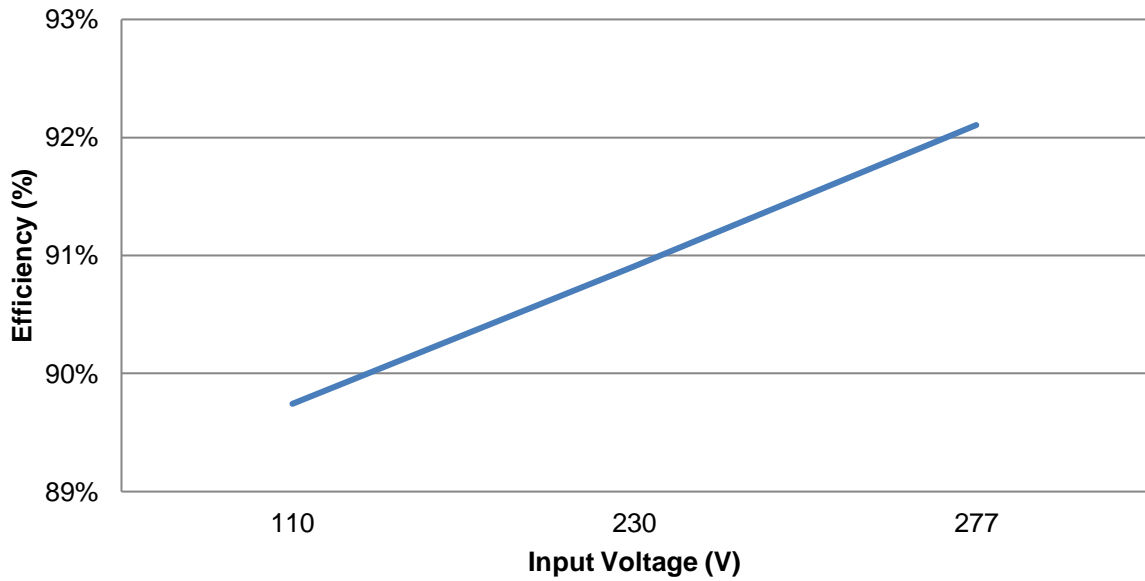

**DSE9481 (MKII) Temperature Derate Curve  
90 V < Vin < 305 V**

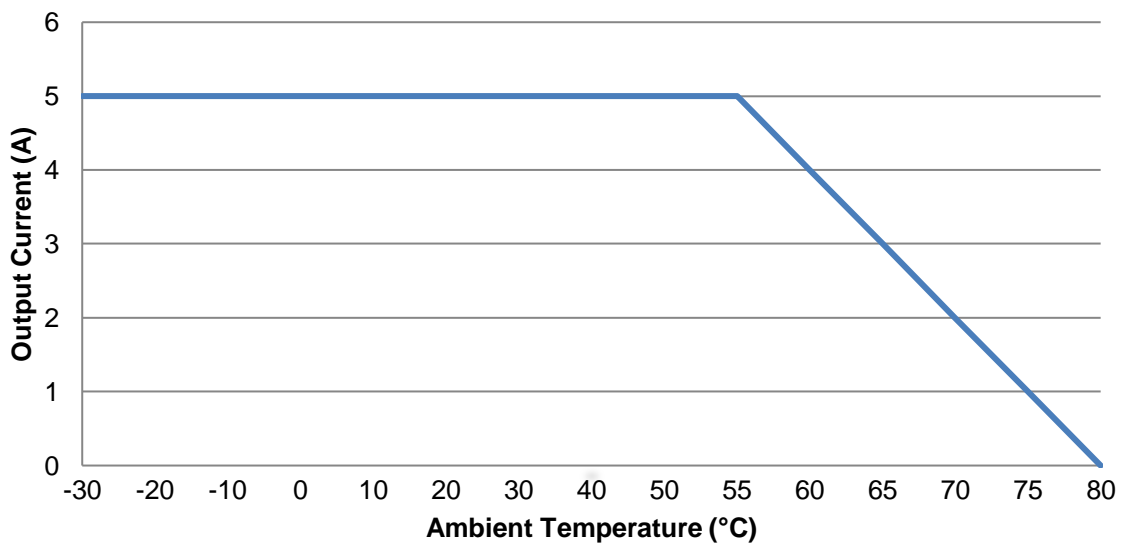

3.4.14 DSE9483 12 V, 15 A

**NOTE:** DSE9483 is factory configured to be a 12 V 15 A. If required, the voltage and current levels can be user configured via DSE Configuration Suite PC Software.

**NOTE:** DSE9483 operates in *Soft Start* when enabled using the DSE Configuration Suite PC Software. For further information on the *Soft Start* feature, refer to *DSE Publication: 057-159 DSE9400 Series Battery Charger Configuration Suite Manual*.

Parameter	Min	Nominal	Max	Comments
Output Voltage (12 V DC Battery)	13 V	14.1 V	15 V	
Output Charging Current (A)	2 A	15 A	16 A	
Current limit threshold (A)		15 A	16 A	
Recovery from current limit (A)	15 A		16 A	
Full load AC input current (A)			1.2 A	At Vin=230 V, Vo=14.4 V, Io=15 A
Full load AC input current (A)			2.2 A	At Vin=110 V, Vo=14.4 V, Io=15 A
AC Input Inrush current (A)		60 A		For 10 ms , 230 V AC Input

**DSE9483 Efficiency Curve at 15 A**

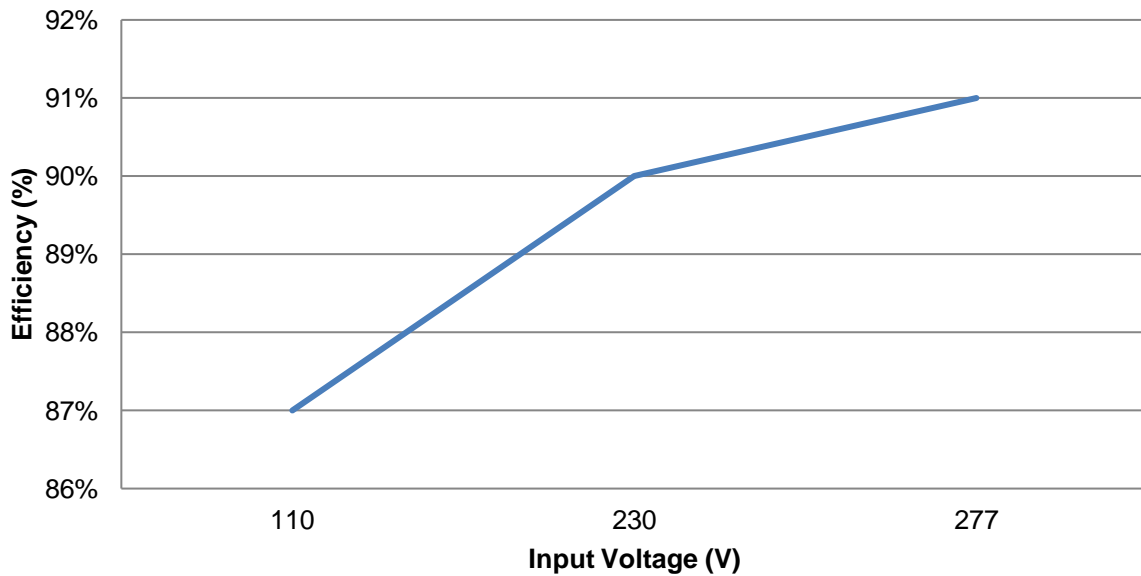

**DSE9483 Temperature Derate Curve  
110 V < Vin < 305 V**

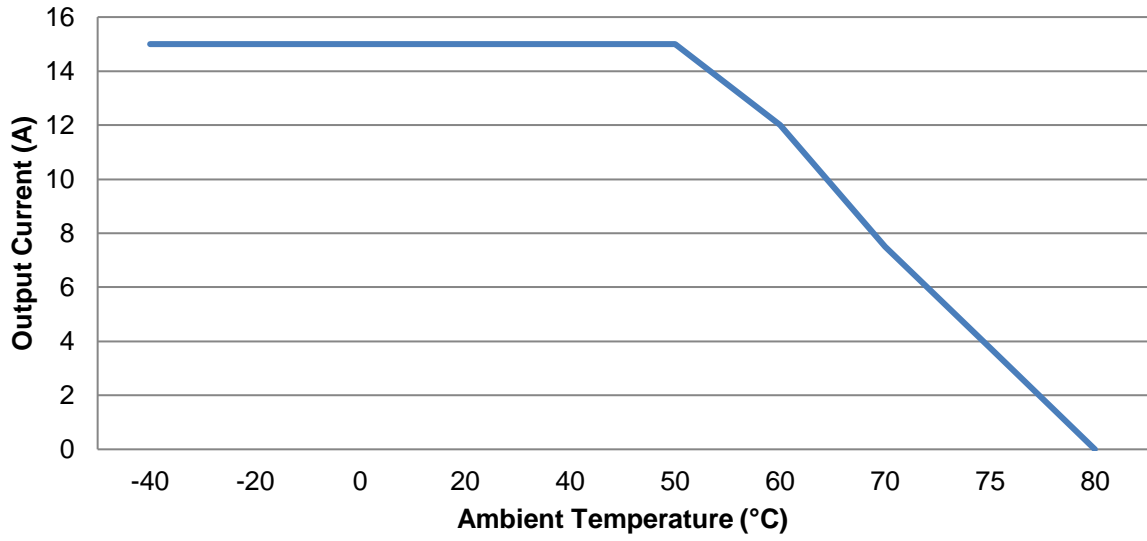

**DSE9483 Temperature Derate Curve  
95 V < Vin < 110 V**

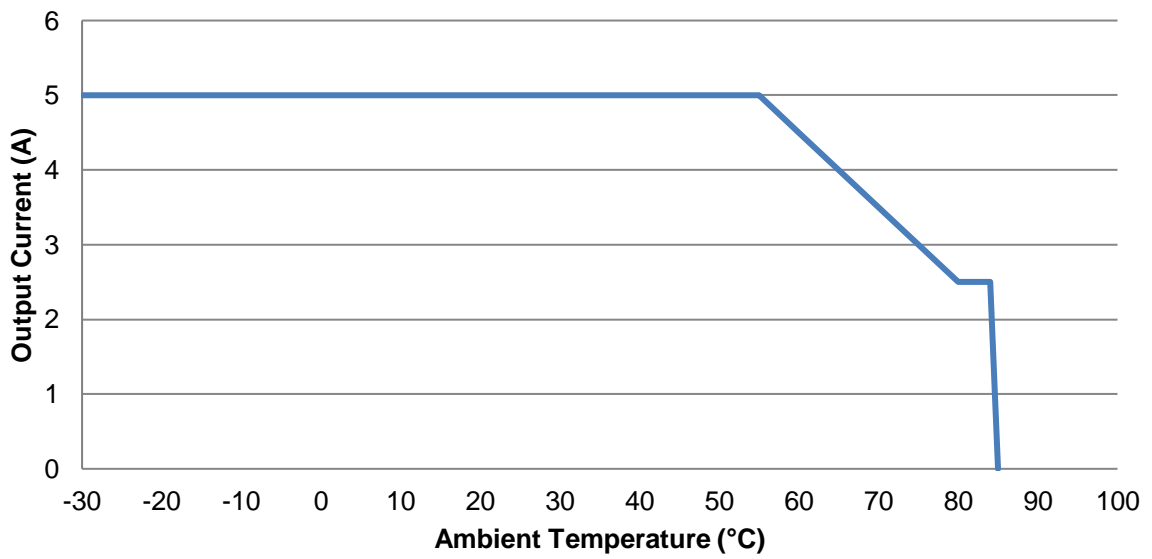

### 3.5 DIMENSIONS AND MOUNTING

#### 3.5.1 DSE907 12 V, 10 A INDUSTRIAL BATTERY CHARGER

Parameter	Comment
Cabinet type	Custom cabinet
Overall size (see below for diagram)	200 mm x 185 mm x 170 mm (7.9" x 7.3" x 6.7") Add 20 mm (0.79") to depth when using supplied mounting plate.
Material:	Sheet steel enclosure of all-round solid construction
Surface finish:	Powder-coated black
Protection category:	IP20 NEMA 1
Weight	5.6 kg
Mounting type	Wall mounting using supplied wall bracket Wall bracket add 20 mm (0.79") to the depth of the enclosure
Mounting holes	Diameter 5 mm (0.2") 130 mm (5.1) centres
Input voltage (nominal)	110 V to 277 V
Input voltage (absolute range)	90 V to 305 V
Charge failure relay rating	3 A DC resistive 30 V maximum
Operating Temperature	-30 °C to 55 °C (-22 °F to 131 °F)
Controls	AC Power on/off
Indication	0 A to 10 A DC ammeter Power on Red neon indicator
AC Fuse	Fuse holder mounted onto front panel. Accepts 2 A anti-surge fuse (20 mm x 5 mm fuse)
DC Fuse	Fuse holder mounted onto front panel. Accepts 5 A anti-surge fuse (20 mm x 5 mm fuse)

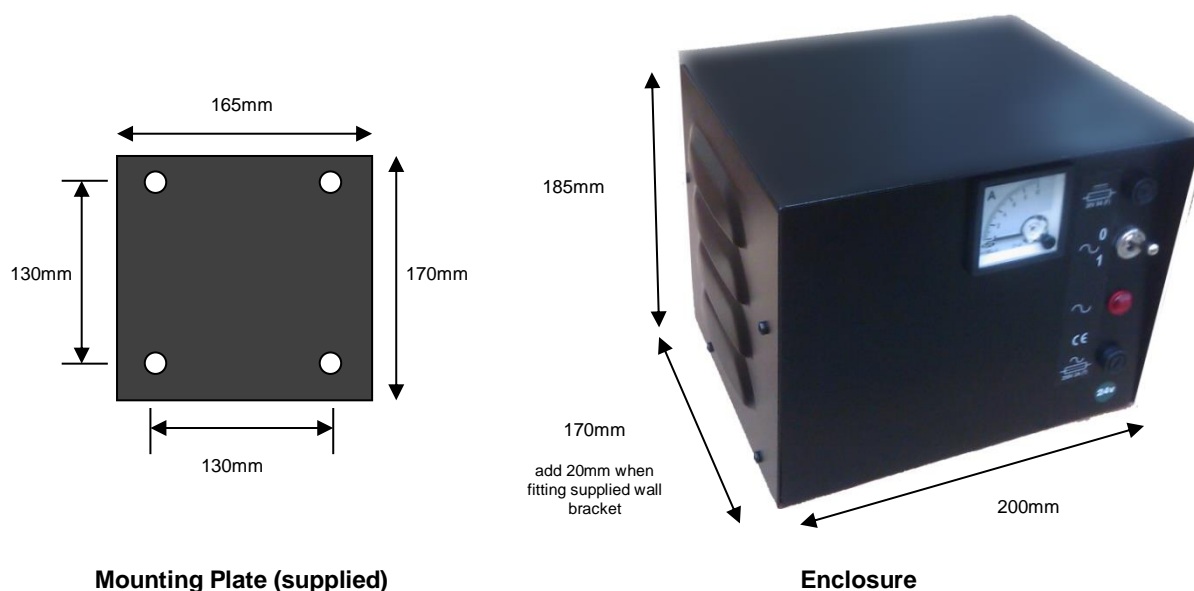

Dimensions in mm



### 3.5.2 DSE908 12 V & 24 V, 10 A CABINET MOUNTED BATTERY CHARGER

Parameter	Comment
Cabinet type	AE1031.500 by Rittal – Rittal website <a href="http://www.rittal.de">www.rittal.de</a> / <a href="http://www.rittal.co.uk">www.rittal.co.uk</a>
Overall size	380 mm x 300 mm x 210 mm (15.0." x 11.8"x 8.3")
Material:	Sheet steel enclosure of all-round solid construction Single door, right hand hinge with one cam lock Foamed-in door seal 1 foamed in gland plate in the enclosure base (Gland plate supplied blank, ready for customer drilling as required).
Surface finish:	Dipcoat primed, powder-coated on the outside in textured RAL 7035
Protection category:	IP20 NEMA 1
Weight	15 kg
Mounting type	Wall mounting. Can be mounted by customer drilled holes or by using Rittal mounting brackets, suitable for Rittal cabinet type AE1030.500 – For example Rittal Part number 2508.010 (Pack of 4) Rittal website <a href="http://www.rittal.de">www.rittal.de</a> / <a href="http://www.rittal.co.uk">www.rittal.co.uk</a>
Input voltage (nominal)	110 V to 277 V
Input voltage (absolute range)	90 V to 305 V
Charge failure relay rating	3 A DC resistive 30 V maximum
Operating Temperature	-30 °C to 55 °C (-22 °F to 131 °F)
Controls	AC Power on/off Boost charge on/off
Indication	0 A to 15 A DC ammeter Power on Red neon indicator
AC Fuse	Fuse holder mounted onto front panel. Accepts 2 A anti-surge fuse (20 mm x 5 mm fuse)



Dimensions in mm

Specifications

3.5.3 DSE9130 12 V, 5 A

**NOTE:** This battery charger is designed to be mounted with the base to a vertical surface with the terminal strips at the bottom.

Parameter	Comment
Overall size	136.48 mm x 140.41 mm x 63.40 mm (5.37" x 5.53" x 2.5")
Weight	0.5 kg
Mounting type	DIN rail or chassis mounting
Din rail type	EN 50022 35 mm type only
Mounting holes	Suitable for M4
Mounting hole centres	119.36 mm x 128.36 mm (4.7" x 5.05")

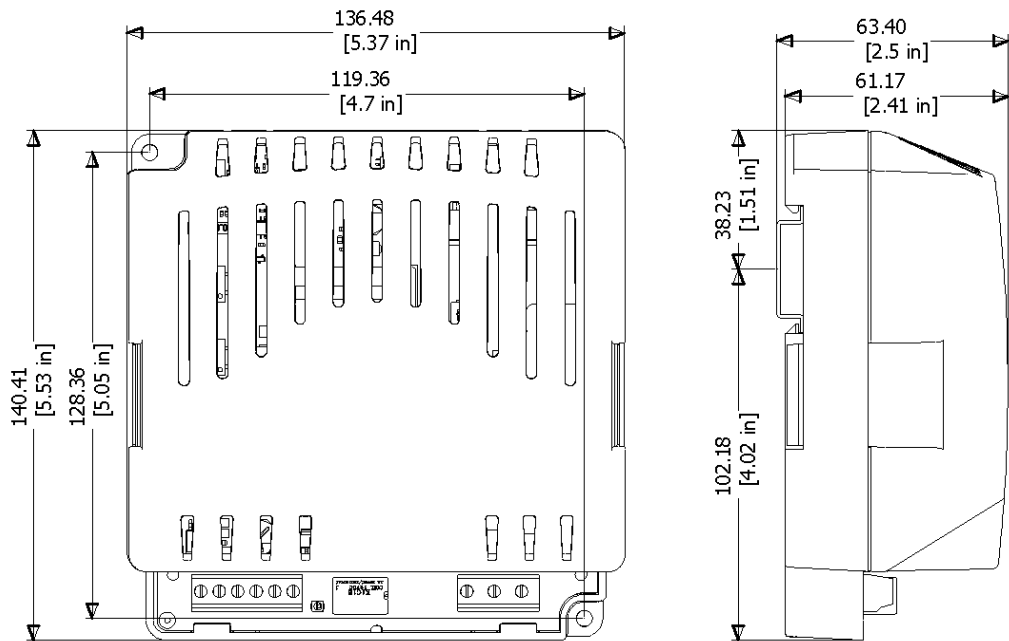

Dimensions in mm unless stated

Specifications

3.5.4 DSE9150 12 V, 2 A

**NOTE:** This device is no longer available, replaced by DSE9150 12V 3A. See overleaf for updated specifications.

**NOTE:** This battery charger is designed to be mounted with the base to a vertical surface with the terminal strips at the bottom.

Parameter	Comment
Overall size	108.03 mm x 101.10 mm x 48.6 mm (4.25" x 3.98" x 1.91")
Weight	0.16 kg
Mounting type	DIN rail or chassis mounting
Din rail type	EN 50022 35 mm type only
Mounting holes	Suitable for M4
Mounting hole centres	91 mm x 89 mm (4.25" x 3.51")

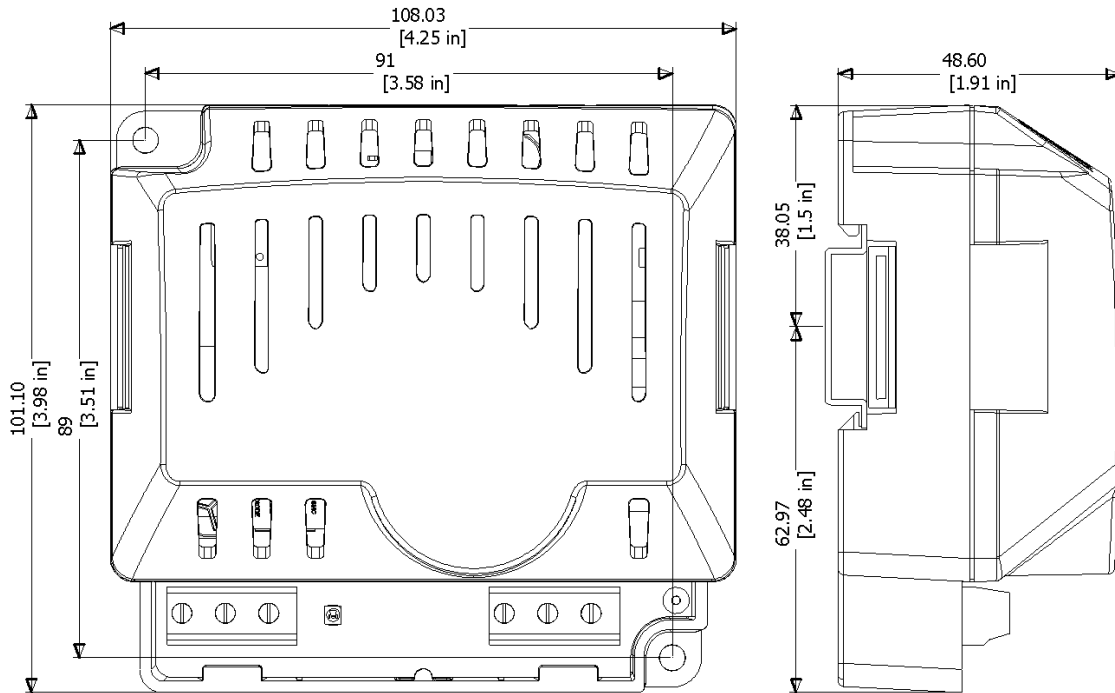

Dimensions in mm unless stated

## Specifications

### 3.5.5 DSE9150 12 V, 3 A

**NOTE:** This device has replaced DSE9150 12 V 2 A. See previous page for specifications of the earlier model.

**NOTE:** This battery charger is designed to be mounted with the base to a vertical surface with the terminal strips at the bottom.

Parameter	Comment
Overall size	108.03 mm x 101.10 mm x 48.6 mm (4.25" x 3.98" x 1.91")
Weight	0.16 kg
Mounting type	DIN rail or chassis mounting
Din rail type	EN 50022 35 mm type only
Mounting holes	Suitable for M4
Mounting hole centres	91 mm x 89 mm (4.25" x 3.51")

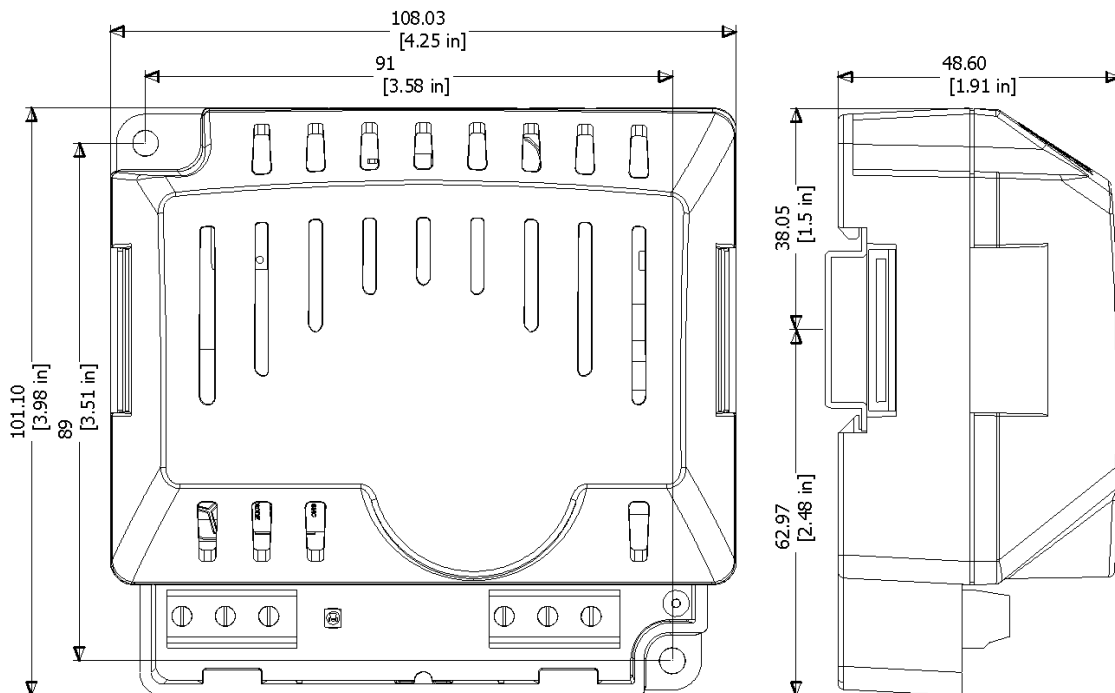

Dimensions in mm unless stated

3.5.6 DSE9140 12 V, 10 A

**NOTE:** This battery charger is designed to be mounted with the base to a vertical surface with the terminal strips at the bottom.

Parameter	Comment
Overall size	152 mm x 188 mm x 2.44 mm (6" x 7.4"x 2.44")
Weight	0.75 kg
Mounting type	DIN rail or chassis mounting
Din rail type	EN 50022 35 mm type only
Mounting holes	Suitable for M4
Mounting hole centres	142 mm x 128 mm (5.59" x 5.0") 30 mm (1.18") from top and bottom edges 5 mm (1.97") from left and right edges.
Input voltage (nominal)	110 V to 277 V
Input voltage (absolute range)	90 V to 305 V
Charge failure relay rating	3 A DC resistive 30 V maximum
Operating Temperature	-30 °C to 55 °C (-22 °F to 131 °F)

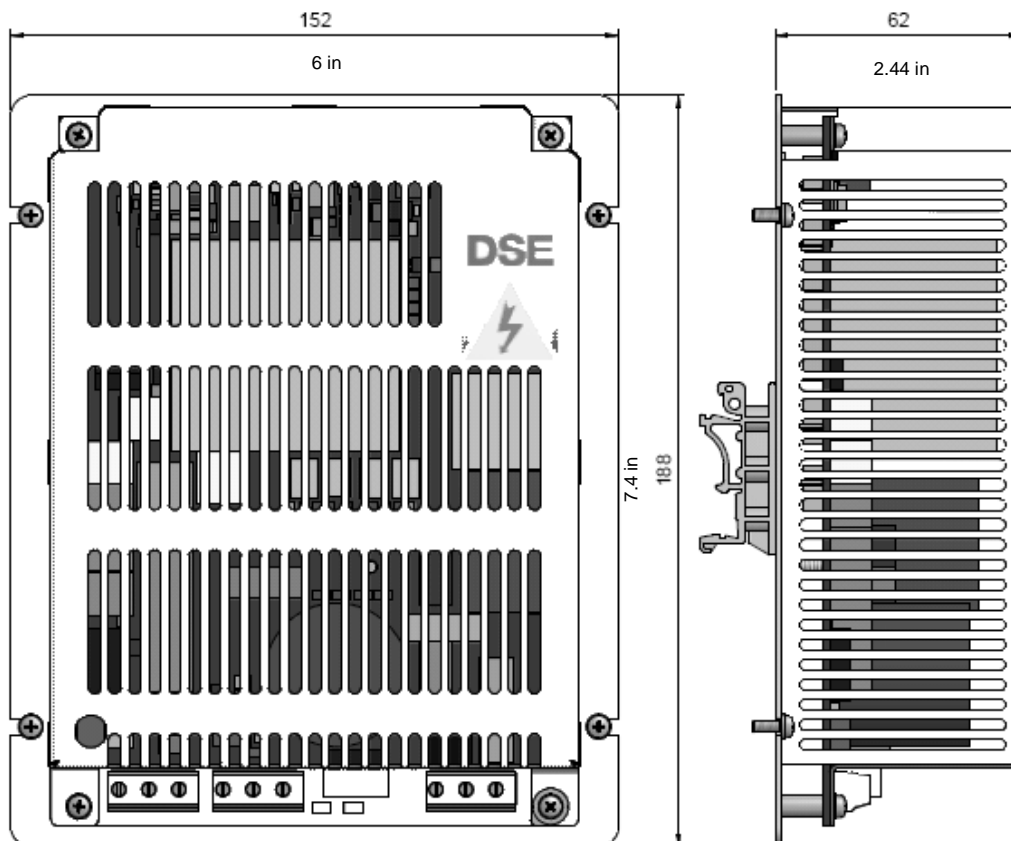

Dimensions in mm unless stated

Specifications

3.5.7 DSE9155 30 V, 2 A

**NOTE:** This battery charger is designed to be mounted with the base to a vertical surface with the terminal strips at the bottom.

Parameter	Comment
Overall size	136.48mm x 140.41mm x 63.40mm (5.37" x 5.53" x 2.5")
Weight	0.5 kg
Mounting type	DIN rail or chassis mounting
Din rail type	EN 50022 35 mm type only
Mounting holes	Suitable for M4
Mounting hole centres	119.36 mm x 128.36 mm 4.7" x 5.05"

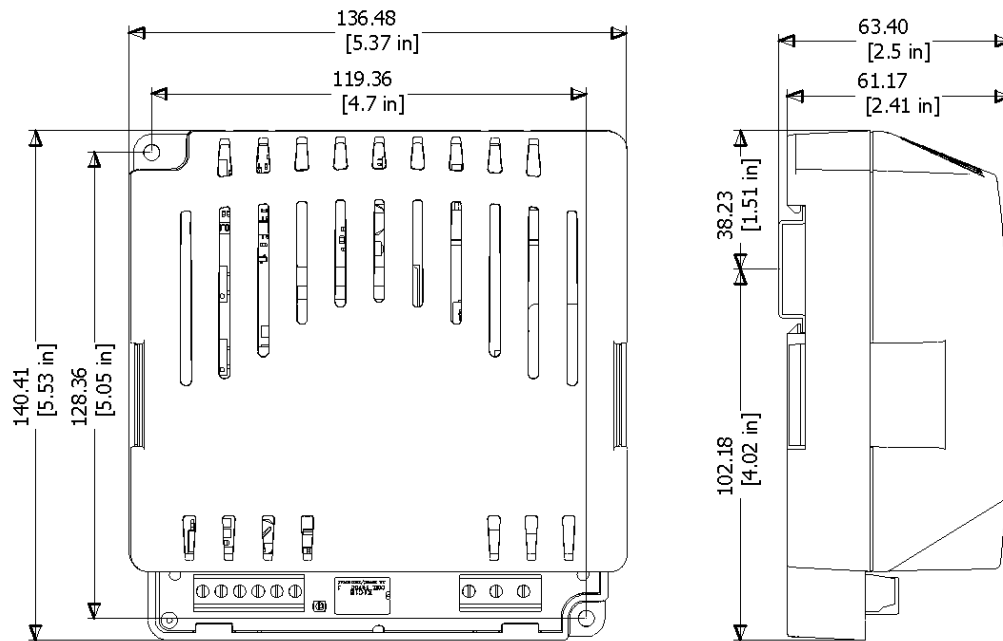

Dimensions in mm unless stated

3.5.8 DSE9250 24 V, 3.7 A

**NOTE:** - This battery charger is now obsolete, details provided for information only.

**NOTE:** This battery charger is designed to be mounted with the base to a vertical surface with the terminal strips at the bottom.

Parameter	Comment
Overall size	136.48 mm x 140.41 mm x 63.40 mm (5.37" x 5.53" x 2.5")
Weight	0.5 kg
Mounting type	DIN rail or chassis mounting
Din rail type	EN 50022 35 mm type only
Mounting holes	Suitable for M4
Mounting hole centres	119.36 mm x 128.36 mm (4.7" x 5.05")

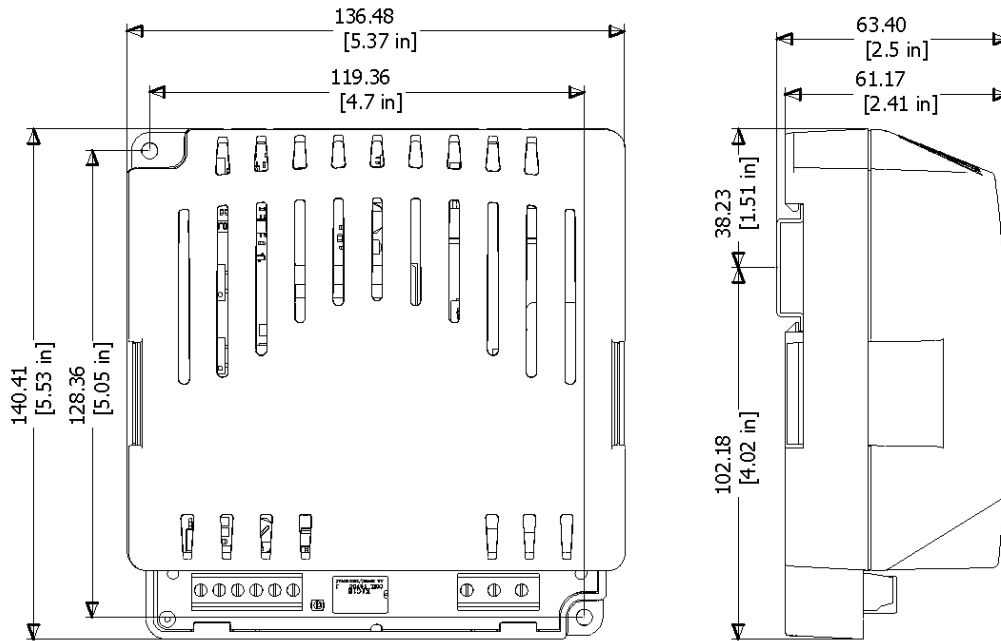

Dimensions in mm unless stated

Specifications

3.5.9 DSE9255 24 V, 5 A

**NOTE:** This battery charger is designed to be mounted with the base to a vertical surface with the terminal strips at the bottom.

Parameter	Comment
Overall size	136.48 mm x 140.41 mm x 63.40 mm (5.37" x 5.53" x 2.5")
Weight	0.5 kg
Mounting type	DIN rail or chassis mounting
Din rail type	EN 50022 35 mm type only
Mounting holes	Suitable for M4
Mounting hole centres	119.36 mm x 128.36 mm (4.7" x 5.05")

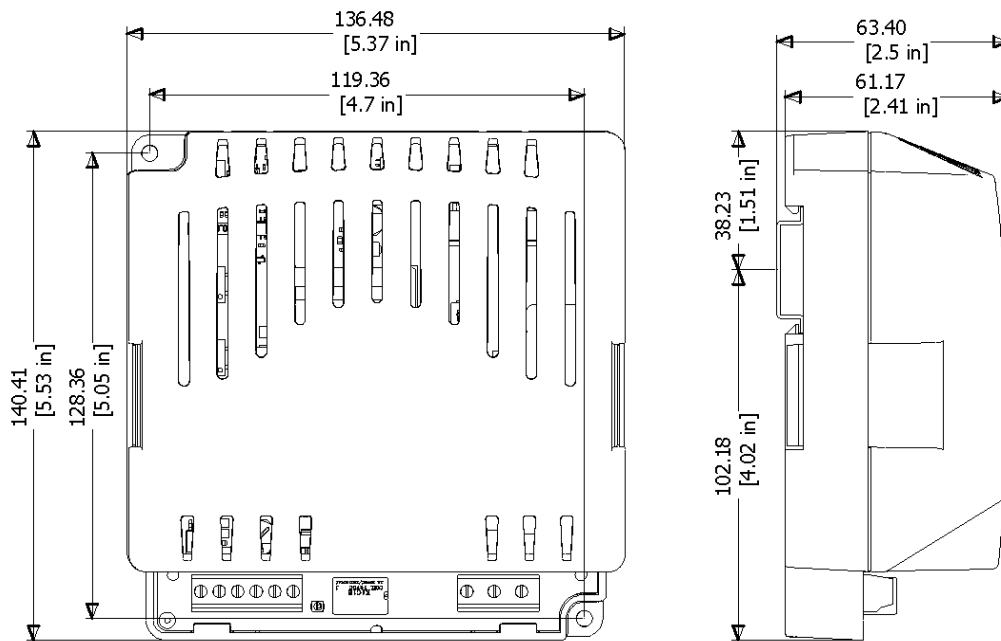

Dimensions in mm unless stated



3.5.10 DSE9260 24 V, 10 A

**NOTE:** This battery charger is designed to be mounted with the base to a vertical surface with the terminal strips at the bottom.

Parameter	Comment
Overall size	152 mm x 188 mm x 2.44 mm (6.0" x 7.4"x 2.44")
Weight	0.85 kg
Mounting type	DIN rail or chassis mounting
Din rail type	EN 50022 35 mm type only
Mounting holes	Suitable for M4
Mounting hole centres	142 mm x 128 mm (5.59" x 5.0")
Input voltage (nominal)	110 V to 277 V
Input voltage (absolute range)	90 V to 305 V
Charge failure relay rating	3 A DC resistive 30 V maximum
Operating Temperature	-30 °C to 55 °C (-22 °F to 131 °F)

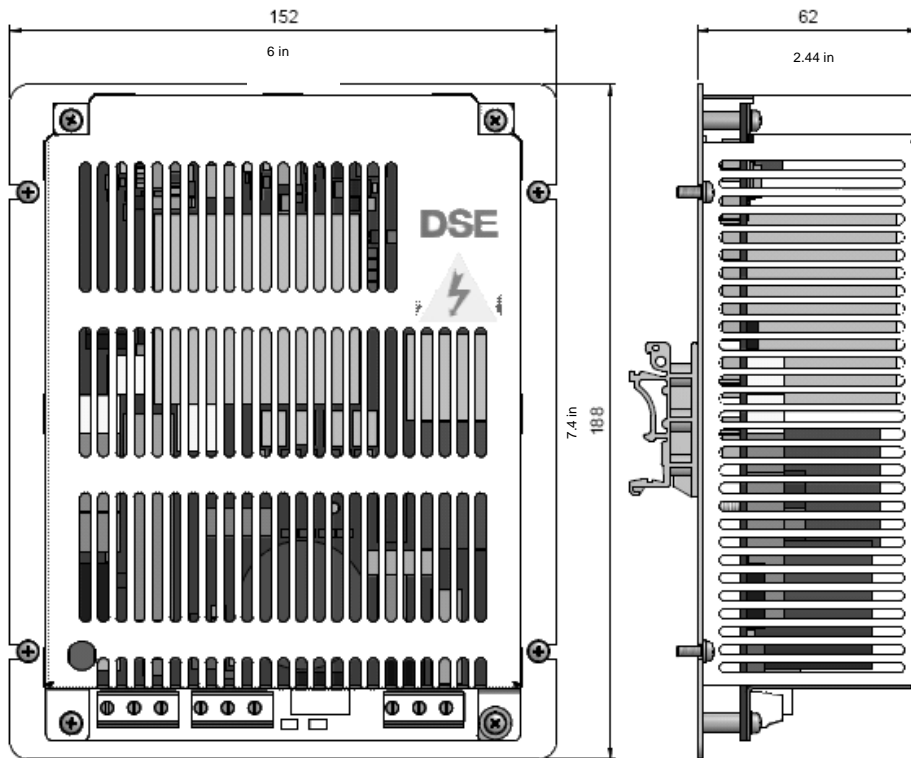

Dimensions in mm unless stated

3.5.11 DSE9470 (MKII) 24 V / 12 V, 10 A

**NOTE:** This battery charger is designed to be mounted with the base to a vertical surface with the terminal strips at the bottom.

Parameter	Comment
Overall size(mm)	205 mm x 135 mm x 80 mm (8.0" x 5.3" x 3.1")
Weight	0.78 kg
Mounting type	DIN rail or chassis mounting
Din rail type	EN 50022 35 mm type only
Mounting holes	Suitable for M4
Mounting hole centres	190 mm x 120 mm (7.5" x 4.7")
Input voltage (nominal)	110 V to 277 V
Input voltage (absolute range)	95 V to 305 V
Charge failure relay rating	3 A DC resistive 30 V maximum
Operating Temperature	-30 °C to 85 °C with de rating (-22 °F to 185 °F with de rating)

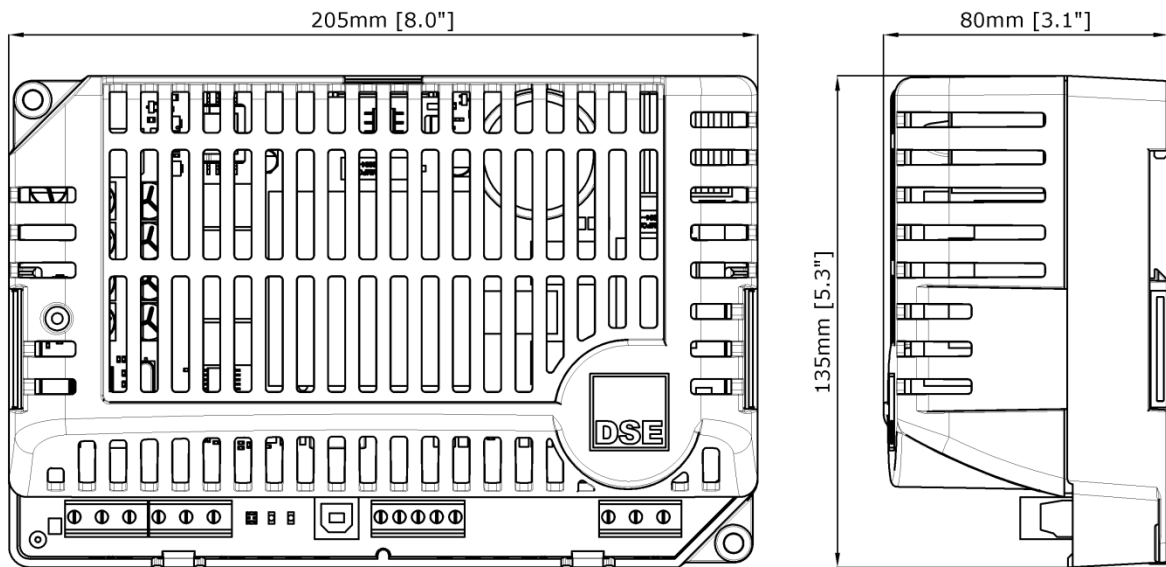

3.5.12 DSE9472 (MKII) 24 V / 12 V, 5 A

**NOTE:** This battery charger is designed to be mounted with the base to a vertical surface with the terminal strips at the bottom.

Parameter	Comment
Overall size(mm)	205 mm x 135 mm x 80 mm (8.0" x 5.3" x 3.1")
Weight	0.7 kg
Mounting type	DIN rail or chassis mounting
Din rail type	EN 50022 35 mm type only
Mounting holes	Suitable for M4
Mounting hole centres	190 mm x 120 mm (7.5" x 4.7")
Input voltage (nominal)	110 V to 277 V
Input voltage (absolute range)	95 V to 305 V
Charge failure relay rating	3 A DC resistive 30 V maximum
Operating Temperature	-30 °C to 85 °C with de rating (-22 °F to 185 °F with de rating)

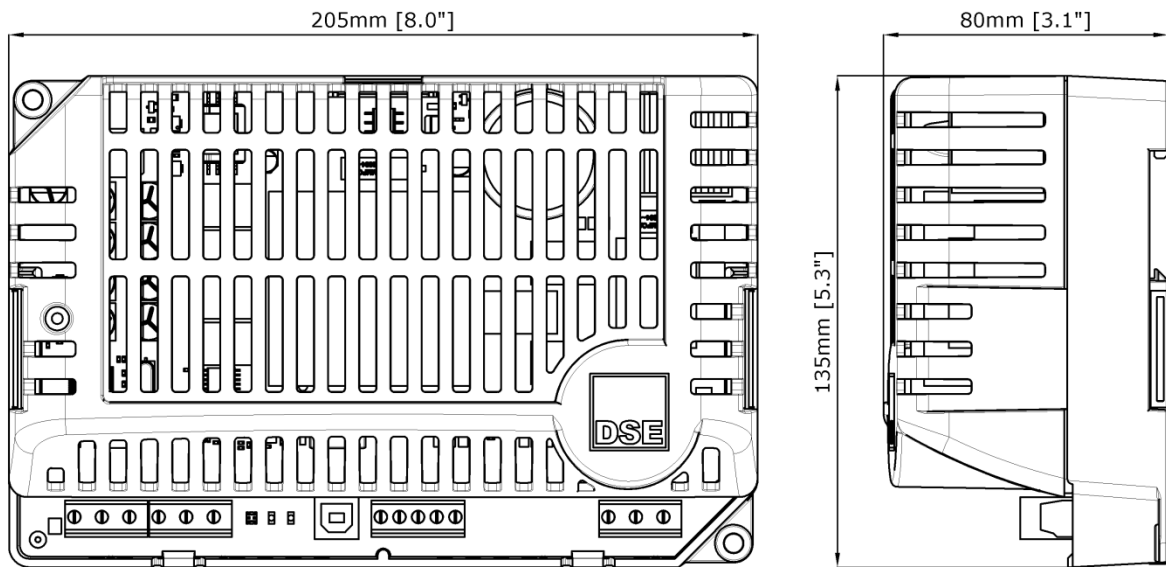

3.5.13 DSE9473 24 V, 15 A

**NOTE:** This battery charger is designed to be mounted with the base to a vertical surface with the terminal strips at the bottom.

Parameter	Comment
Overall size(mm)	205 mm x 135 mm x 80 mm (8.0" x 5.3" x 3.1")
Weight	0.78 kg
Mounting type	DIN rail or chassis mounting
Din rail type	EN 50022 35 mm type only
Mounting holes	Suitable for M4
Mounting hole centres	190 mm x 120 mm (7.5" x 4.7")
Input voltage (nominal)	110 V to 277 V
Input voltage (absolute range)	95 V to 305 V
Charge failure relay rating	3 A DC resistive 30 V maximum
Operating Temperature	-30 °C to 75 °C with de-rating (-22 °F to 185 °F with de-rating)

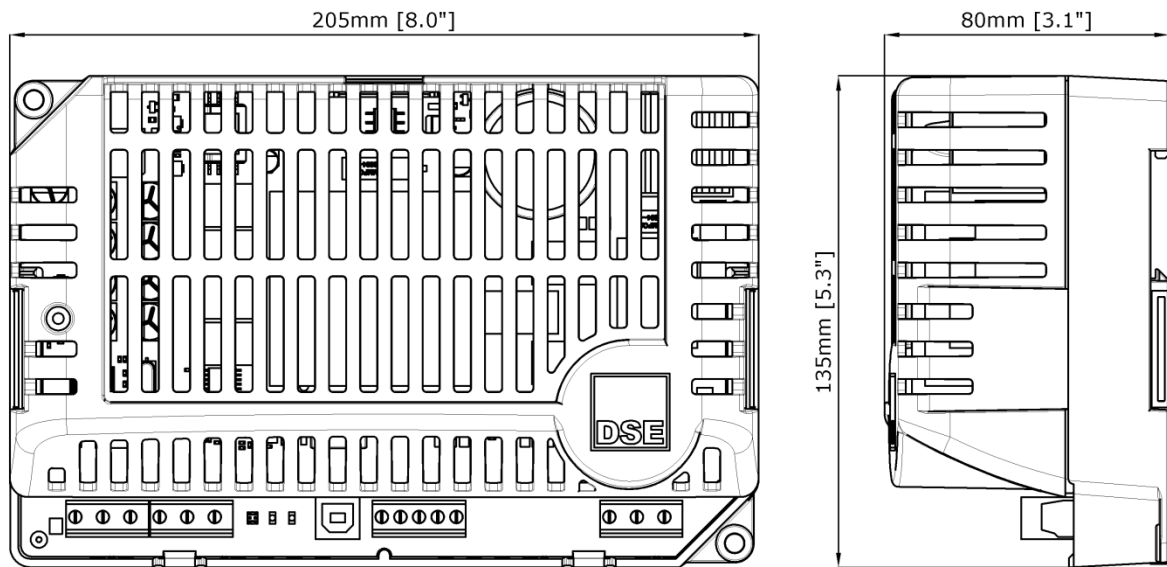

**3.5.14 DSE9480 (MKII) 12 V / 24 V, 10 A**

**▲ NOTE: This battery charger is designed to be mounted with the base to a vertical surface with the terminal strips at the bottom.**

Parameter	Comment
Overall size(mm)	205 mm x 135 mm x 80 mm (8.0" x 5.3" x 3.1")
Weight	0.7 kg
Mounting type	DIN rail or chassis mounting
Din rail type	EN 50022 35 mm type only
Mounting holes	Suitable for M4
Mounting hole centres	190 mm x 120 mm (7.5" x 4.7")
Input voltage (nominal)	110 V to 277 V
Input voltage (absolute range)	95 V to 305 V
Charge failure relay rating	3 A DC resistive 30 V maximum
Operating Temperature	-30 °C to 85 °C with de rating (-22 °F to 185 °F with de rating)

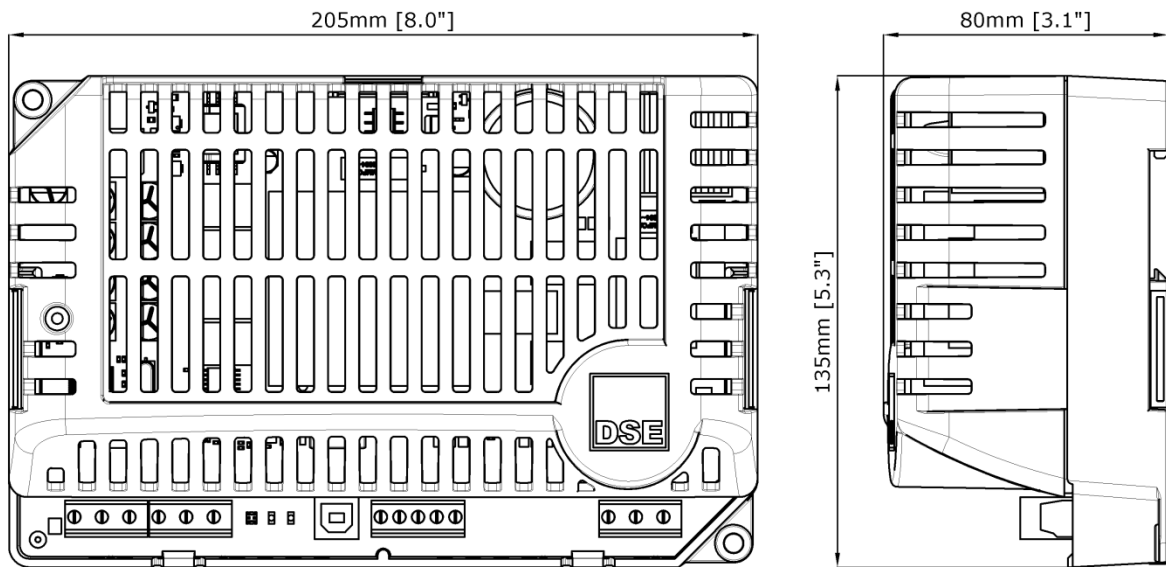

3.5.15 DSE9481 (MKII) 12 V / 24 V, 5 A

**NOTE:** This battery charger is designed to be mounted with the base to a vertical surface with the terminal strips at the bottom.

Parameter	Comment
Overall size(mm)	205 mm x 135 mm x 80 mm (8.0" x 5.3" x 3.1")
Weight	0.7 kg
Mounting type	DIN rail or chassis mounting
Din rail type	EN 50022 35 mm type only
Mounting holes	Suitable for M4
Mounting hole centres	190 mm x 120 mm (7.5" x 4.7")
Input voltage (nominal)	110 V to 277 V
Input voltage (absolute range)	95 V to 305 V
Charge failure relay rating	3 A DC resistive 30 V maximum
Operating Temperature	-30 °C to 85 °C with de rating (-22 °F to 185 °F with de rating)

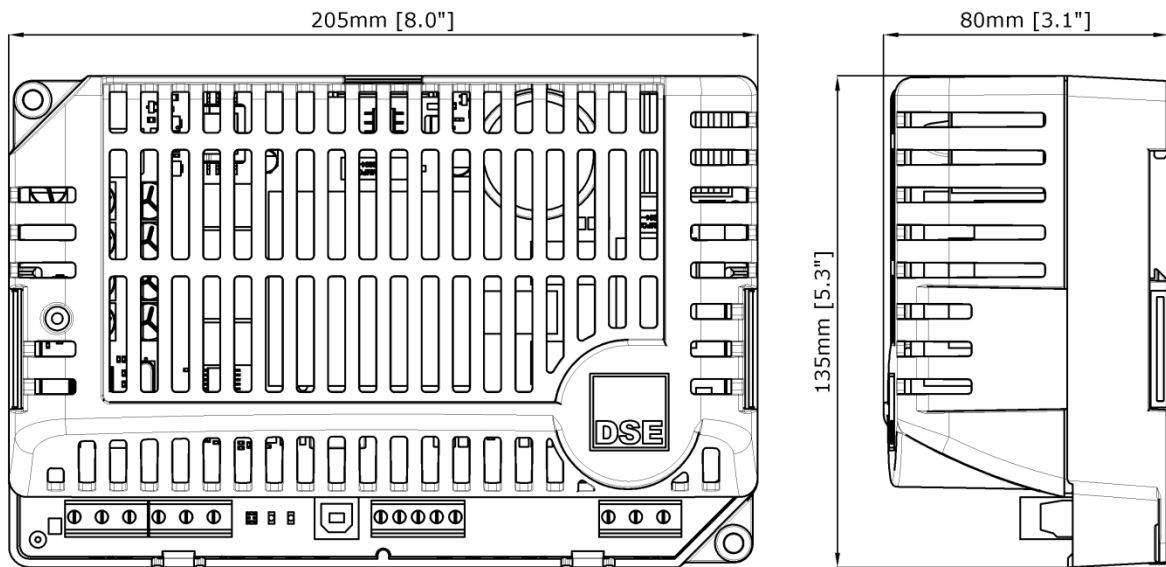

3.5.16 DSE9483 12 V, 15 A

**NOTE:** This battery charger is designed to be mounted with the base to a vertical surface with the terminal strips at the bottom.

Parameter	Comment
Overall size(mm)	205 mm x 135 mm x 80 mm (8.0" x 5.3" x 3.1")
Weight	0.78 kg
Mounting type	DIN rail or chassis mounting
Din rail type	EN 50022 35 mm type only
Mounting holes	Suitable for M4
Mounting hole centres	190 mm x 120 mm (7.5" x 4.7")
Input voltage (nominal)	110 V to 277 V
Input voltage (absolute range)	95 V to 305 V
Charge failure relay rating	3 A DC resistive 30 V maximum
Operating Temperature	-30 °C to 75 °C with de rating (-22 °F to 185 °F with de rating)

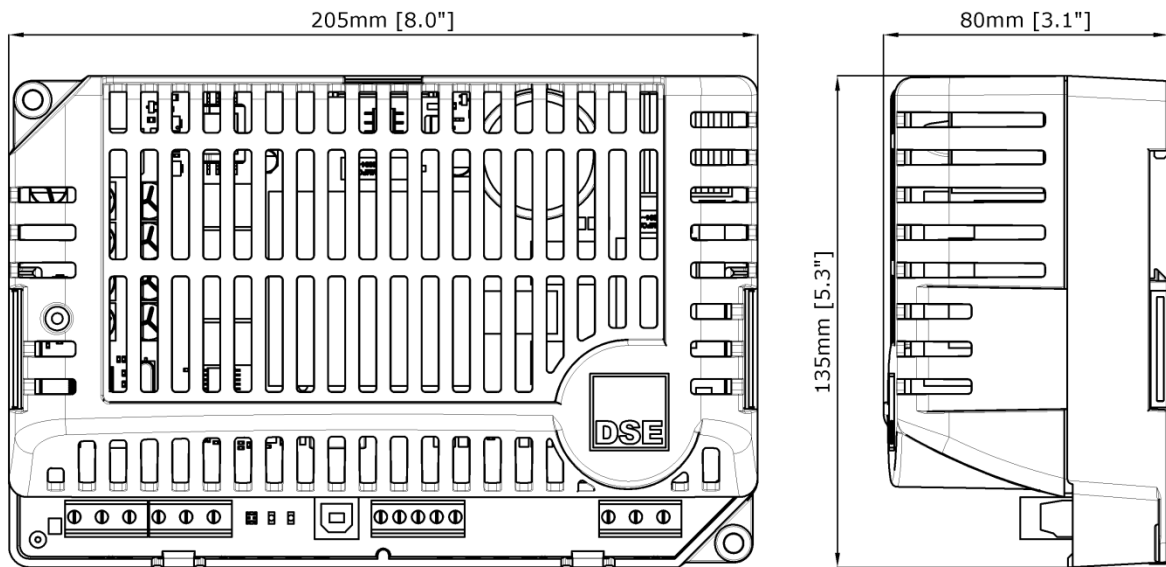

### 3.6 APPLICABLE STANDARDS

<b>BS EN 60529</b> (Degrees of protection provided by enclosures)	IP20  Protected against penetration by solid objects with a diameter of more than 12 mm. Fingers or similar objects prevented from approach.  No protection against water
<b>UL508</b> <b>NEMA rating</b>	Enclosure type 1  Provides a degree of protection against contact with the enclosure equipment and against a limited amount of falling dirt

In line with our policy of continual development, Deep Sea Electronics, reserve the right to change specification without notice.



## 4 INSTALLATION

**NOTE:** The DSE9xx, 91xx, 92xx & 94xx series battery chargers should only be used to charge one battery bank at a time. It is not recommended to parallel batteries as the tolerance of the batteries leads to imbalance in their charging.

The DSE9000 battery charger is designed to be mounted within a control panel, on the panel DIN rail utilising the integral mounts or on a chassis utilising the mounting holes. For dimension and mounting details, see the section entitled *Specification, Dimensions* elsewhere in this document.

The DSE9000 battery charger is *fit-and-forget*. It can be permanently connected to the supply and the load, with no requirement to disable the charger during times of heavy load (such as engine cranking) or when the generator is running (even when a DC charging alternator is fitted).

### 4.1 BATTERY SUITABILITY

The *standard* charger is factory set by DSE to suit Lead Acid batteries but can be adjusted at the time of ordering to suit other battery types. Care should be taken to ensure the batteries connected to the charger are of the correct 'technology' to suit the setting of the charger. For details of other supported battery types and *float voltages* see the section entitled *Specifications, Part Numbering* elsewhere in this document.

### 4.2 USER CONNECTIONS

Parameter	Comment	
Connection type	Screw terminal, rising clamp, no internal spring	
Min cable size	0.5 mm <sup>2</sup> (AWG 20)	
Max cable size	2.5 mm <sup>2</sup> (AWG 10)	
<b>Recommended AC fuse</b>	<b>230 V AC Input</b>	<b>110 V AC Input</b>
DSE9130 12 V 5 A charger	1.0 A anti-surge	2.0 A anti-surge
DSE9140 12 V 10 A charger	2.0 A anti-surge	3.5 A anti-surge
DSE9150 12 V 2 A charger	1.0 A anti-surge	1.5 A anti-surge
DSE9150 12 V 3 A charger	1.5 A anti-surge	2.0 A anti-surge
DSE9155 30 V 2 A charger	1.0 A anti-surge	2.5 A anti-surge
DSE9250 24 V 3.7 A charger	1.0 A anti-surge	2.5 A anti-surge
DSE9260 24 V 10 A charger	3.5 A anti-surge	6.3 A anti-surge
DSE9255 24 V 5 A charger	2.0 A anti-surge	3.5 A anti-surge
DSE9470 24 V / 12 V 10 A charger	3.5 A anti-surge	6.3 A anti-surge
DSE9472 24 V / 12 V 5 A charger	2.0 A anti-surge	6.3 A anti-surge
DSE9473 24 V 15 A charger	3.5 A anti-surge	6.3 A anti-surge
DSE9480 12 V / 24 V 10 A charger	2.0 A anti-surge	3.5 A anti-surge
DSE9481 12 V / 24 V 5 A charger	1.0 A anti-surge	2.5 A anti-surge
DSE9483 12 V 15 A charger	2.0 A anti-surge	3.5 A anti-surge

**NOTE:** Where the current rating has been user configured below the rated maximum current, an appropriate fuse size must be selected to match the lower maximum output current.

#### 4.2.1 DSE9130, DSE9140, DSE9250, DSE9255, DSE9260, DSE9701 & DSE9702

##### Connector A

Terminal	Function	Recommended Size	Comments
-OP	Load negative	1 mm <sup>2</sup> (AWG 16)	Battery negative terminal
+OP	Load Positive	1 mm <sup>2</sup> (AWG 16)	Battery positive terminal
BOOST	Boost mode	0.5 mm <sup>2</sup> (AWG 22)	Connect together for boost operation
BOOST	Boost mode	0.5 mm <sup>2</sup> (AWG 22)	
CF	Charge failure relay	0.5 mm <sup>2</sup> (AWG 22)	De-energises under charge fail conditions
CF	Charge failure relay	0.5 mm <sup>2</sup> (AWG 22)	

##### Connector B

Terminal	Function	Recommended Size
	Earth	1 mm <sup>2</sup> (AWG 16)
N	AC Neutral	1 mm <sup>2</sup> (AWG 16)
L	AC Live	1 mm <sup>2</sup> (AWG 16)

**! CAUTION:** Ensure Earth Terminal is connected to Battery negative (for negative earth systems) or Battery positive (for positive earth systems)  
Where no system earth exists, Earth Terminal must be connected to battery negative

**NOTE:** For further details on the *Charge Failure Relay*, refer to the section entitled *Protection* elsewhere in this manual.

#### 4.2.2 DSE9150

##### Connector A

Terminal	Function	Recommended Size	Comments
NC	Not Connected		Do not connect
-OP	Load negative	1 mm <sup>2</sup> (AWG 16)	Battery negative terminal
+OP	Load Positive	1 mm <sup>2</sup> (AWG 16)	Battery positive terminal

##### Connector B

Terminal	Function	Recommended Size
	Earth	1 mm <sup>2</sup> (AWG 18)
N	AC Neutral	1 mm <sup>2</sup> (AWG 18)
L	AC Live	1 mm <sup>2</sup> (AWG 18)

**! CAUTION:** Ensure Earth Terminal is connected to Battery negative (for negative earth systems) or Battery positive (for positive earth systems)  
Where no system earth exists, Earth Terminal must be connected to battery negative

### 4.2.3 DSE9155

#### Connector A

Terminal	Function	Recommended size	Comments
-OP	Load negative	1 mm <sup>2</sup> (AWG 16)	Battery negative terminal
+OP	Load Positive	1 mm <sup>2</sup> (AWG 16)	Battery positive terminal
BOOST	N/A	0.5 mm <sup>2</sup> (AWG 22)	Boost not available on DSE9155
BOOST	N/A	0.5 mm <sup>2</sup> (AWG 22)	
CF	Charge failure relay	0.5 mm <sup>2</sup> (AWG 22)	De-energises under charge fail conditions
CF	Charge failure relay	0.5 mm <sup>2</sup> (AWG 22)	

#### Connector B

Terminal	Function	Recommended Size
	Earth	1 mm <sup>2</sup> (AWG 16)
N	AC Neutral	1 mm <sup>2</sup> (AWG 16)
L	AC Live	1 mm <sup>2</sup> (AWG 16)

**!** CAUTION: Ensure Earth Terminal is connected to Battery negative (for negative earth systems) or Battery positive (for positive earth systems).  
Where no system earth exists, Earth Terminal must be connected to battery negative.

**▲** NOTE: For further details on the *Charge Failure Relay*, refer to the section entitled *Protection* elsewhere in this manual.

4.2.4 DSE9470 MKII, DSE9472 MKII, DSE9480 MKII & DSE9481 MKII

**NOTE:** For obsolete parts 9470-001-00 and 9480-001-00 contact DSE Technical Support for connection details.

**Connector A**

Terminal	Function	Recommended size	Comments
-OP	Load negative	2.5 mm <sup>2</sup> (AWG 10)	Battery negative terminal
+OP	Load Positive	2.5 mm <sup>2</sup> (AWG 10)	Battery positive terminal

**Connector B**

Terminal	Function	Recommended size	Comments
LK1	Configurable Input	1 mm <sup>2</sup> (AWG 16)	Connect the terminals together to activate the input. *The Factory Setting for the digital input provides a selection of 12 V / 24 V operation. Customer configurable using DSE Configuration Suite PC Software.
LK1	Configurable Input (0V)	1 mm <sup>2</sup> (AWG 16)	
NC	Normally Closed Contact of the Charge failure relay	0.5 mm <sup>2</sup> (AWG 22)	De-energises Under Charge Fail Conditions
COM	Charge failure relay Contact Common	0.5 mm <sup>2</sup> (AWG 22)	
NO	Normally Open Contact of the Charge failure relay	0.5 mm <sup>2</sup> (AWG 22)	

**NOTE:** Digital Input Not Fitted to 9470-001-00 and 9480-001-00.  
\*DSE9473/DSE9483 Factory Setting = Lamp Indication Test

**NOTE:** For further details of PC Configuration, you are referred to *DSE Publication: 057-159 DSE9400 Series Battery Charger Configuration Suite Manual*.

**NOTE:** For further details on the *Charge Failure Relay*, refer to the section entitled *Protection* elsewhere in this manual.

**Connector C**

Terminal	Function	Recommended size	Comments
SCR	RS485 screen	0.5 mm <sup>2</sup> (AWG20)	Use only 120 Ω RS485 approved cable
A	RS485 -ve	0.5 mm <sup>2</sup> (AWG20)	Use only 120 Ω RS485 approved cable
B	RS485 +ve	0.5 mm <sup>2</sup> (AWG20)	Use only 120 Ω RS485 approved cable
NTC	PT1000 connection terminals	0.5 mm <sup>2</sup> (AWG20)	Use only PT1000
NTC		0.5 mm <sup>2</sup> (AWG20)	

**Connector D**

Terminal	Function	Recommended Size
	Earth	1 mm <sup>2</sup> (AWG 16)
N	AC Neutral	1 mm <sup>2</sup> (AWG 16)
L	AC Live	1 mm <sup>2</sup> (AWG 16)

**⚠ CAUTION: Ensure Earth Terminal is connected to Battery negative (for negative earth systems) or Battery positive (for positive earth systems)  
Where no system earth exists, Earth Terminal must be connected to battery negative**

#### 4.2.5 DSE9473 & DSE9483

##### Connector A

Terminal	Function	Recommended size	Comments
-OP	Load negative	2.5 mm <sup>2</sup> (AWG 10)	Battery negative terminal
+OP	Load Positive	2.5 mm <sup>2</sup> (AWG 10)	Battery positive terminal

##### Connector B

Terminal	Function	Recommended size	Comments
LK1	Configurable Input	1 mm <sup>2</sup> (AWG 16)	Connect the terminals together to activate the input. *The Factory Setting for the digital input provides a selection of 12 V / 24 V operation. Customer configurable using DSE Configuration Suite PC Software.
LK1	Configurable Input (0V)	1 mm <sup>2</sup> (AWG 16)	
NC	Normally Closed Contact of the Charge failure relay	0.5 mm <sup>2</sup> (AWG 22)	De-energises Under Charge Fail Conditions
COM	Charge failure relay Contact Common	0.5 mm <sup>2</sup> (AWG 22)	
NO	Normally Open Contact of the Charge failure relay	0.5 mm <sup>2</sup> (AWG 22)	

 **NOTE: Digital Input Factory Setting = Lamp Indication Test**

 **NOTE: For further details of PC Configuration, you are referred to *DSE Publication: 057-159 DSE9400 Series Battery Charger Configuration Suite Manual.***

 **NOTE: For further details on the *Charge Failure Relay*, refer to the section entitled *Protection* elsewhere in this manual.**

##### Connector C

Terminal	Function	Recommended size	Comments
SCR	RS485 screen	0.5 mm <sup>2</sup> (AWG20)	Use only 120 Ω RS485 approved cable
A	RS485 -ve	0.5 mm <sup>2</sup> (AWG20)	Use only 120 Ω RS485 approved cable
B	RS485 +ve	0.5 mm <sup>2</sup> (AWG20)	Use only 120 Ω RS485 approved cable
NTC	PT1000 connection terminals	0.5 mm <sup>2</sup> (AWG20)	Use only PT1000
NTC		0.5 mm <sup>2</sup> (AWG20)	

##### Connector D

Terminal	Function	Recommended Size
	Earth	1 mm <sup>2</sup> (AWG 16)
N	AC Neutral	1 mm <sup>2</sup> (AWG 16)
L	AC Live	1 mm <sup>2</sup> (AWG 16)

 **CAUTION: Ensure Earth Terminal is connected to Battery negative (for negative earth systems) or Battery positive (for positive earth systems)  
Where no system earth exists, Earth Terminal must be connected to battery negative**

### 4.3 TYPICAL WIRING DIAGRAM

#### 4.3.1 DSE9150

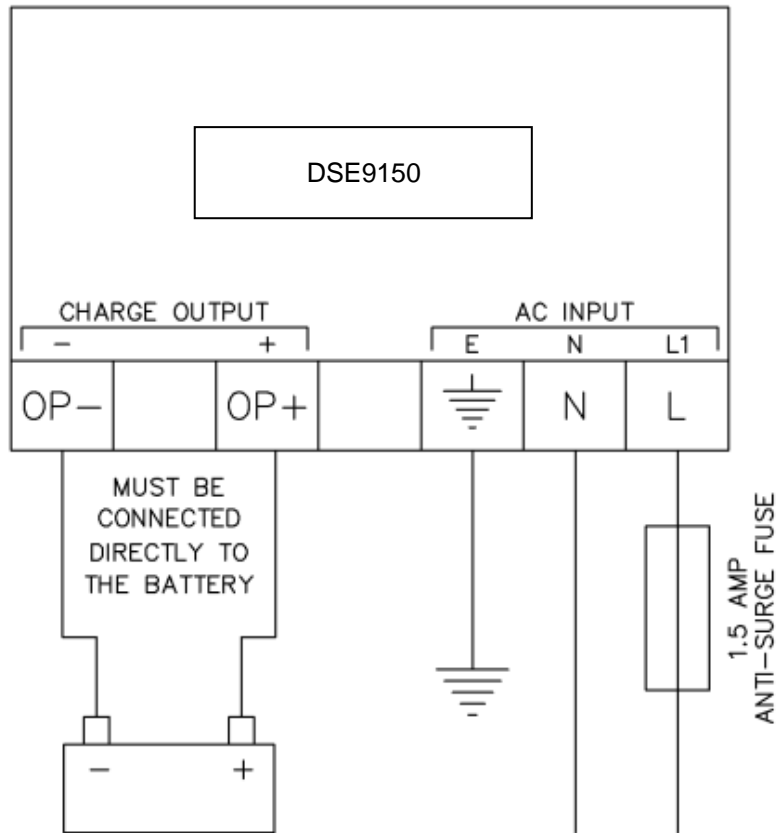

Recommended AC fuse	230 V AC Input	110 V AC Input
DSE9150 12 V 2 A charger (see Note below)	1.0 A anti-surge	1.5 A anti-surge
DSE9150 12 V 3 A charger	1.5 A anti-surge	2.0 A anti-surge

**NOTE: DSE9150 12 V 2 A is no longer available and is included for legacy support only.**



4.3.2 DSE9155 & DSE9200 SERIES

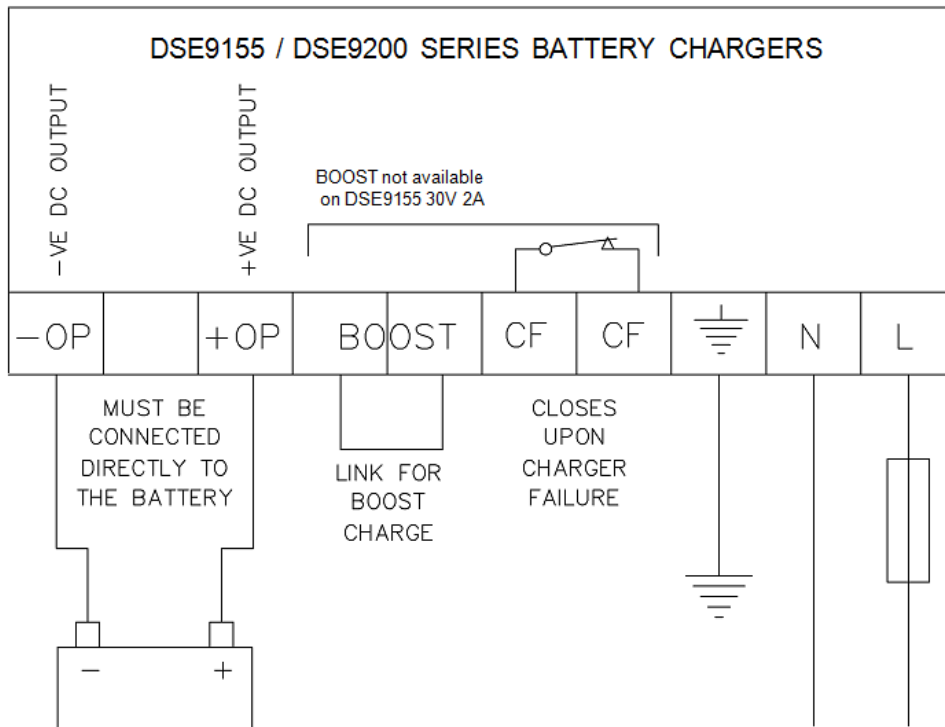

Recommended AC fuse	230V AC Input	110V AC Input
DSE9130 12 V 5 A charger	1.0 A anti-surge	2.0 A anti-surge
DSE9140 12 V 10 A charger	2.0 A anti-surge	3.5 A anti-surge
DSE9155 30 V 2 A charger	1.0 A anti-surge	2.5 A anti-surge
DSE9250 24 V 3.7 A charger	1.0 A anti-surge	2.5 A anti-surge
DSE9260 24 V 10 A charger	3.5 A anti-surge	6.3 A anti-surge
DSE9255 24 V 5 A charger	2.0 A anti-surge	3.5 A anti-surge

### 4.3.3 DSE9470 MKII, DSE9472 MKII, DSE9480 MKII & DSE9481 MKII

**NOTE:** For obsolete parts 9470-001-00 and 9480-001-00 contact DSE Technical Support for connection details.

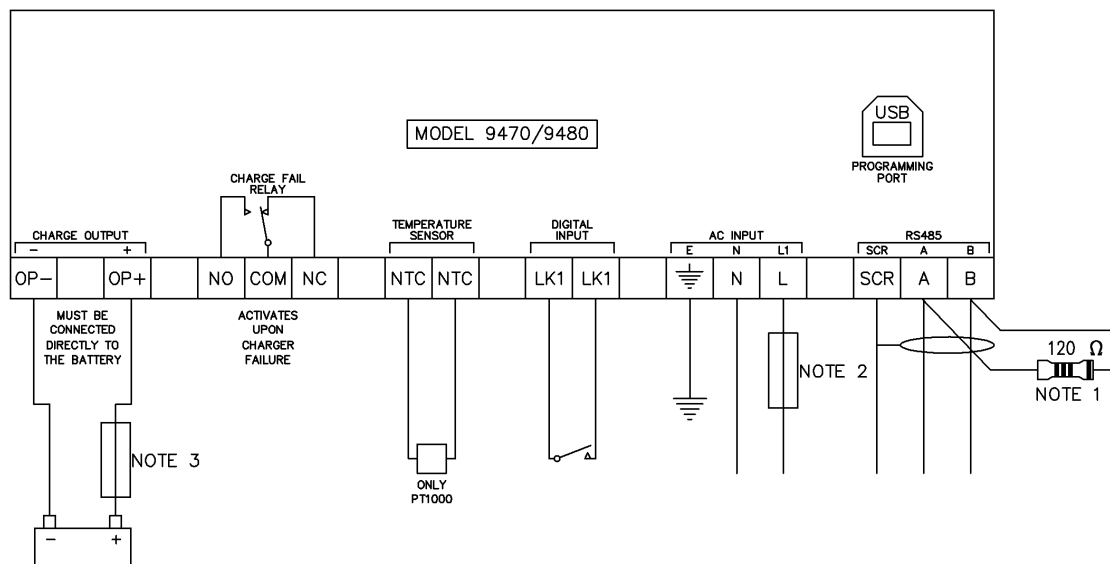

TERMINALS SUITABLE FOR 22–16 AWG (0.6mm<sup>2</sup> – 1.3mm<sup>2</sup>) FIELD WIRING  
TIGHTENING TORQUE = 0.5Nm (4.5lb-in)

NOTE 1  
A 120 OHM TERMINATION RESISTOR MUST BE FITTED IF IT IS THE FIRST OR LAST DEVICE ON AN RS485 LINK

NOTE 2

AC INPUT	ANTI-SURGE FUSE RATING
110V	6.3A
230V	3.5A

WHEN CURRENT LIMIT IS CONFIGURED BELOW 10A, FUSE APPROPRIATELY

NOTE 3  
FUSE APPROPRIATELY AND AS CLOSE TO THE BATTERY AS POSSIBLE TO PROTECT THE CABLES AND BATTERY

Recommended AC fuse	230 V AC Input	110 V AC Input
DSE9470 MKII 24 V / 12V 10 A charger	3.5 A anti-surge	6.3 A anti-surge
DSE9472 MKII 24 V / 12 V 5 A charger	2.0 A anti-surge	3.5 A anti-surge
DSE9480 MKII 12 V / 24 V 10 A charger	2.0 A anti-surge	3.5 A anti-surge
DSE9481 MKII 12 V / 24 V 5 A charger	1.0 A anti-surge	2.5 A anti-surge

4.3.4 DSE9473 & DSE9483

**NOTE:** Where current rating has been user configured, an appropriate fuse size must be selected to match the lower maximum output current.

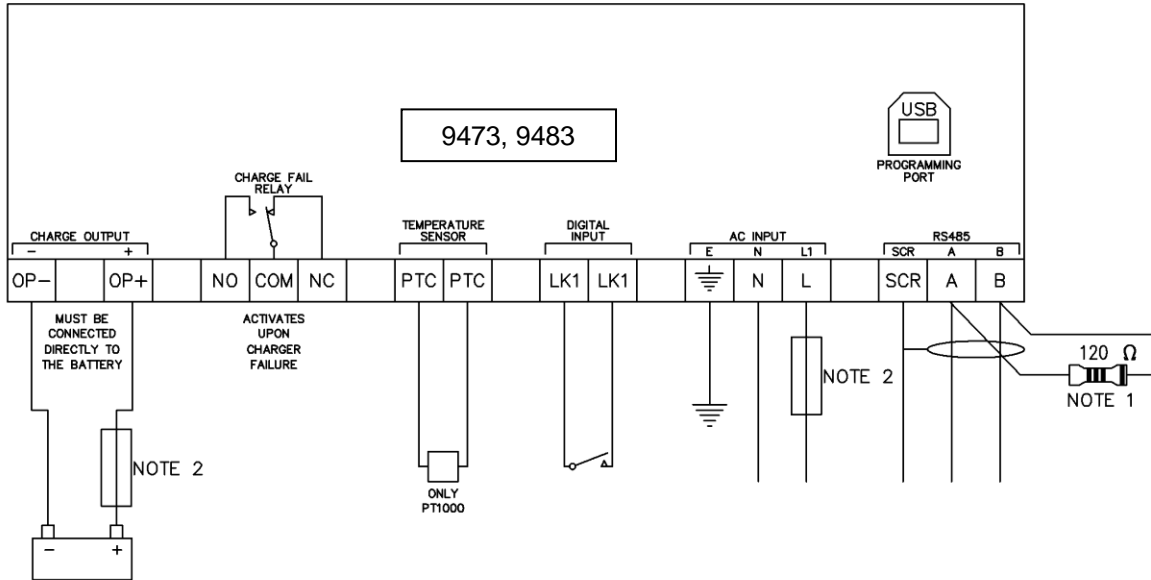

NOTE 1  
A 120 OHM TERMINATION RESISTOR MUST BE FITTED IF IT IS THE FIRST OR LAST DEVICE ON AN RS485 LINK

NOTE 2  
FUSE APPROPRIATELY AND AS CLOSE TO THE BATTERY AS POSSIBLE TO PROTECT THE CABLES AND BATTERY

Recommended AC fuse	230 V AC Input	110 V AC Input
DSE9473 24 V 15 A charger	3.5 A anti-surge	6.3 A anti-surge
DSE9483 12 V 15 A charger	2.0 A anti-surge	3.5 A anti-surge

## 5 INDICATIONS

 **DANGER OF DEATH : LIVE PARTS exist within the DSE9000 enclosure. The enclosure cover must not be removed when connected to an AC supply.**

### 5.1 DSE907



Function	Action
Power indication	Illuminated RED when AC power is connected and the POWER switch is in the '1' position
Charge Ammeter	Scaled 0A to 10A to show charge current (Max 5A charge)

### 5.2 DSE908

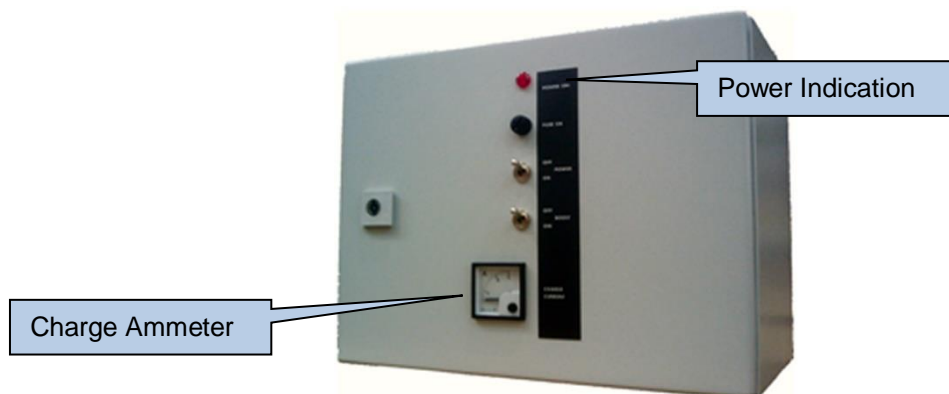

Function	Action
Power indication	Illuminated RED when AC power is connected and the POWER switch is in the ON position
Charge Ammeter	Scaled 0 A to 15 A to show charge current (Max 5 A charge)

### 5.3 DSE9130, DSE9150, DSE9155, DSE9250 & DSE9255

DSE9130 12 V, 5 A  
 DSE9155 30 V, 2 A  
 DSE9250 24 V, 3.7 A  
 DSE9255 24 V, 5 A

DSE9150 12 V, 2 A  
 DSE9150 12 V, 3 A

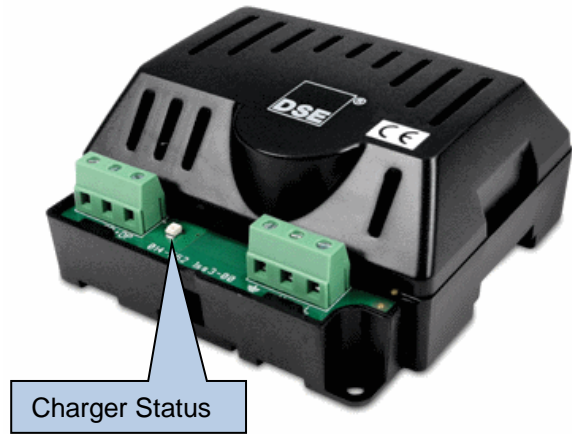
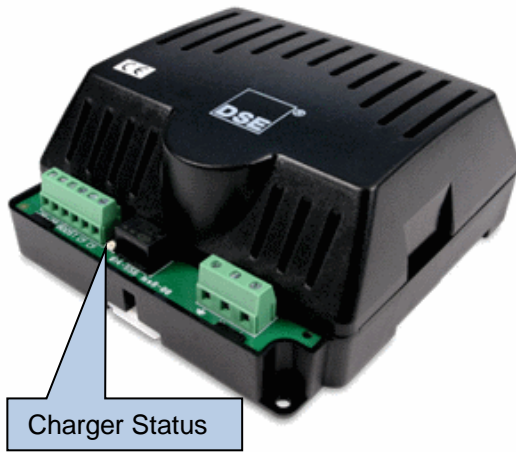

#### LED Indications

Function	Colour	Action
Charger Status	Red	<ul style="list-style-type: none"> <li>• Off when AC supply is not present or output volts are too low.</li> <li>• Steady during normal operation with AC supply above minimum operating voltage.</li> <li>• Flashing when connected to an operating charging alternator.</li> <li>• Pulsing during overload conditions.</li> </ul>

### 5.4 DSE9140 & DSE9260

DSE9140 12 V, 10 A  
DSE9260 24 V, 10 A

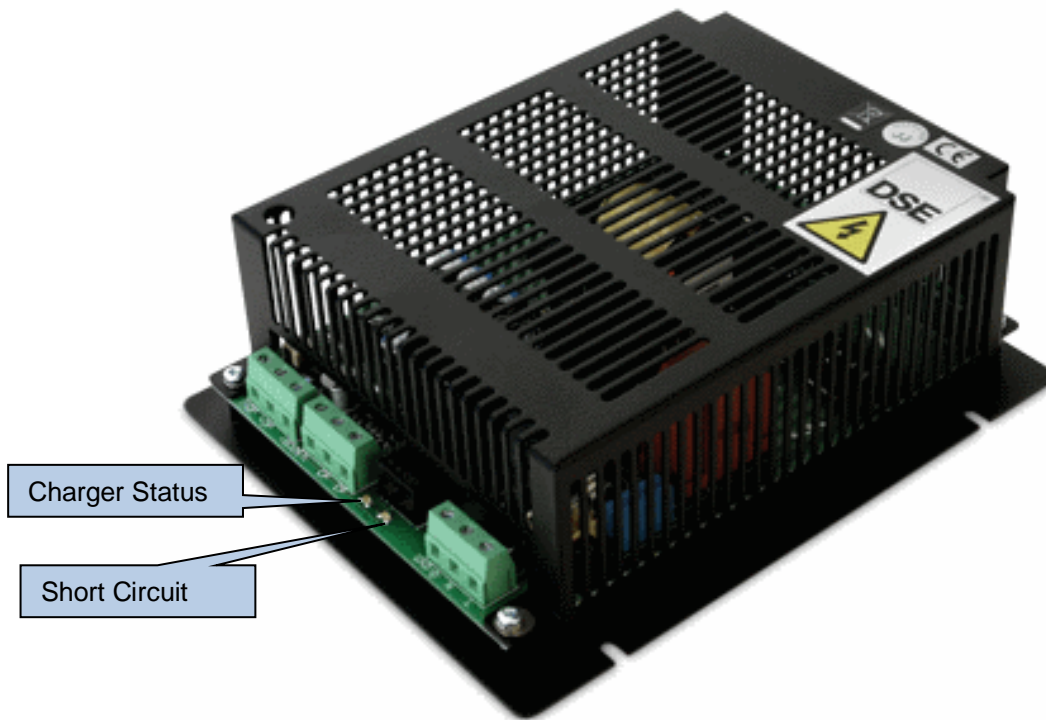

#### LED Indications

Function	LED	Action
Charger Status	Red	<ul style="list-style-type: none"> <li>Off when AC supply is not present or output voltage is too low</li> <li>Steady during normal operation with AC supply above minimum operating voltage</li> <li>Flashing when connected to an operating charging alternator</li> </ul>
Short circuit and reverse polarity indication	Green	<ul style="list-style-type: none"> <li>Off when AC supply is not present or output voltage is too low</li> <li>Steady during normal operation with AC supply above minimum operating voltage</li> <li>Flashing during short circuit or reverse polarity conditions</li> </ul>

## 5.5 DSE9470 MKII, DSE9472 MKII, DSE9480 MKII & DSE9481 MKII

 **NOTE:** For obsolete parts 9470-001-00 and 9480-001-00 contact DSE Technical Support for LED descriptions.

### 5.5.1 STATUS

LCondition	LED Designation		
	OPE	FAULT1	FAULT2
Charger Off	Off	Off	Off
Battery not Detected (Battery Detection Mode)	Green Flashing	Red Flashing	Red Flashing
Battery Connected (Battery Detection Mode)	Green Constant	Red Constant	Red Constant
Not Charging (Charger is operating correctly but the output has been disconnected from the battery)	Off	Red Constant	Red Constant

### 5.5.2 CHARGE MODE

Mode	LED Designation
	OPE
Bulk Charge in Progress	Yellow Constant
Absorption Charge in Progress	Yellow Flashing
Float Charge in Progress	Green Constant
Storage Charge in Progress	Green Flashing

### 5.5.3 FAULT CONDITIONS

Condition	LED Designation	
	FAULT1	FAULT2
High Output Voltage (DC)	Red Constant	Off
High / Low Input Voltage (AC) or High Output Current (DC)	Red Flashing	Off
High Ambient / Charger Temperature, High Battery Temperature (if enabled)	Off	Red Constant
Short Circuit/ Reverse Polarity (DC Output Connection)	Off	Red Flashing

## 6 OPERATION

### 6.1 OPERATION OF DSE9100 SERIES & DSE9200 SERIES

DSE9100 SERIES	DSE9200 SERIES
DSE9130 12 V 5 A	DSE9250 24 V 3.7 A
DSE9140 12 V 10 A	DSE9255 24 V 5 A
DSE9150 12 V 2 A	DSE9260 24 V 10 A
DSE9150 12 V 3 A	
DSE9155 30 V 2 A	

The DSE9100 & DSE9200 series of battery chargers can be used as a battery charger, DC power supply, or both at the same time. For instance, the units can be used to power the generator control panels and charge the panel batteries or starter batteries at the same time.

With no AC input to the charger, the *Charge fail* relay will be closed. This can be used to provide indication of charger failure which operates upon mains supply AC supply failure or upon one of the protections being activated.

#### 6.1.1 PROTECTION

- Current limit to charger specification (2 A or 3 A depending upon charger model)
- Short circuit protection. Charger automatically restarts operation after the fault is removed.
- Reverse battery polarity protection. Charger automatically restarts operation after the fault is removed.

#### 6.1.2 PSU MODE

If no battery is connected to the output terminals, the DSE9100 & DSE9200 series battery charger will operate as a DC power supply only, current limit is factory set. See the section entitled *Specification* elsewhere in this manual for output specifications.

#### 6.1.3 CHARGE MODE

##### Constant Voltage

The DSE9100 & DSE9200 series battery charger operates in *Constant voltage current limited* mode. The charger output voltage is maintained at a constant level to allow the battery to charge while the load does not exceed the maximum rating of the charger. Once the battery is fully charged, the DSE9100 & DSE9200 series battery charger will switch to *ECO-POWER* mode. This is a low power use *standby* mode.

##### Current Limit

If the load on the battery charger (*battery charge demand+standing load*) exceeds the maximum current rating of the charger, the charging current is limited to the maximum rating of the charger and the voltage is reduced.

The voltage will rise to the rated voltage again once the load drops below the maximum rating of the charger.



### Charging time

Charge time is often of little consequence when the battery is used in a *standby* operation. An example of this is when the battery is used to supply the starting system of a diesel generator. During normal operation, the battery is at full capacity and the battery charger is used to maintain the float voltage of the battery. The battery is only drained when the generator is called to start. As the generator has a DC charging alternator fitted, the battery is quickly recharged when the generator is running. Should the generator stop before the battery is fully recharged, the DSE9100 & DSE9200 series will continue to recharge the battery until it is fully charged.

Typically, a battery will charge from flat to 80% capacity in 16hrs when charged at C/10. For example, charging a 50 Ah battery for 16 hrs at 5 A will charge the battery to 80% of its full capacity.

Remember to take into account any other standing load such as control panel requirements when calculating how much power is 'left' to charge the battery.

### 6.1.4 BOOST MODE

(Not applicable to DSE9150 12 V 2 A, DSE9150 12 V 3 A or DSE9155 30 V 2 A)

 <b>CAUTION: Boost mode is intended for equalisation of the cells in lead acid batteries and should not be operated when the battery charger is connected to other battery types or when the charger is used as a power supply only. If in doubt, consult your battery manufacturer.</b>
---

Boost mode is operated by connecting the *BOOST* terminals together (for instance with an external switch or timer circuit). This will raise the battery charger floating voltage by 0.8 V DC.

## 6.2 OPERATION OF DSE9470 MKII, DSE9472 MKII, DSE9473, DSE9480 MKII, DSE9481 MKII & DSE9483

 **NOTE:** For details of Battery Charger Configuration, you are referred to DSE Publication: 057-159 DSE9400 Series Battery Charger Configuration Suite Manual.

The DSE9400 MKII Series battery charger can be used as a battery charger, DC power supply, or both at the same time. For instance, the unit can be used to power the generator control panels and charge the panel batteries or starter batteries at the same time.

With no AC input to the charger, the *Fault* relay is in its inactive state. This volts-free change over relay can be used to provide indication of alarms as detailed in the Protection section below. When a suitable AC supply is connected, operation of the unit will depend upon the load connected to the unit's output terminals:

### 6.2.1 PROTECTION

 **NOTE:** The *Fault Relay* is configured by default to change state upon any fault occurring. If required, using *DSE Configuration Suite PC Software*, the user can configure the *Fault Relay* to ignore all *Mains Under/Over Voltage Warning* or *Mains Failure* situations, while continuing to operate upon activation of any other alarm. For more details you are referred to DSE Publication: 057-159 DSE9400 Series Battery Charger Configuration Suite Manual.

Alarms fall into two categories:

- Shutdown Alarms, non-adjustable alarms.
- User Configurable Alarms, adjustable by DSE Configuration Suite PC Software.

### 6.2.1.1 SHUTDOWN ALARMS

 **NOTE:** The Shutdown alarm are factory set and cannot be changed.

 **NOTE:** When the AC supply source falls outside the hardware voltage limits, the DSE charger is instantly switched off for safety reasons, and the alarm is activated (**Fault Relay De-energises**).

 **NOTE:** The *Fault Relay* is configured by default to change state upon any fault occurring. If required, using *DSE Configuration Suite PC Software*, the user can configure the *Fault Relay* to ignore all *Mains Under/Over Voltage Warning* or *Mains Failure* situations, while continuing to operate upon activation of any other alarm. For more details you are referred to DSE Publication: 057-159 DSE9400 Series Battery Charger Configuration Suite Manual.

Under the following conditions, the Fault Relay de-energises to the normally closed state and charging is stopped (DC output is disabled) :

- AC Power removed
- AC Power outside the hardware limits (Minimum & Maximum AC input voltage and frequency as detailed in the *Common Electrical Specifications* table for each specific charger)
- Battery temperature > 60 °C (if temperature compensation is enabled)
- Battery Charger ambient temperature > 85 °C
- DC output voltage > 110% of Boost Voltage
- Short circuit / reverse polarity of the DC output.

### 6.2.1.2 USER CONFIGURABLE ALARMS

 **NOTE:** For details of Battery Charger Configuration, you are referred to DSE Publication: 057-159 DSE9400 Series Battery Charger Configuration Suite Manual.

 **NOTE:** When a *Shutdown Alarm* is active at the same time as a *User Configurable Alarm*, the *Shutdown Alarm* takes priority and switches the charger off.

The following alarms are user configurable using DSE Configuration Suite PC Software. In each case, the Fault relay de-energises.

- DC Overcurrent alarm
- DC Overvoltage alarm
- Battery Temperature alarm. Activation of this alarm places the charger into Float mode.
- Mains Over Voltage alarm. Activation of this alarm places the charger into Float mode.
- Mains Under Voltage alarm. Activation of this alarm places the charger into Float mode.

### 6.2.2 DIGITAL INPUT

The DSE9400 series is fitted with a configurable digital input. Configuration is made using the DSE Configuration Suite PC Software.

The Factory Setting for the digital input provides a *12 V / 24 V selection* function.

### 6.2.3 VOLTAGE ADJUSTMENT POTENTIOMETER

A manually operated potentiometer is provided to make small adjustments to the *Boost Voltage* without the requirement for the DSE Configuration Suite PC Software.

This is primarily intended to increase charger output to cater for voltage drop in long connection cables.

The potentiometer adjusts the *boost voltage* by up to  $\pm 1.7$  V. This is subject to an absolute maximum of 29.5 V.

The table below shows the effect of the potentiometer on the *boost voltage* in the various charging modes.

Charge Mode	Effect on <i>boost voltage</i>
Bulk	100% of potentiometer setting
Absorption	50% of potentiometer setting
Float	Potentiometer has no effect on <i>Float Voltage</i>
Storage	Potentiometer has no effect on <i>Storage Voltage</i>

### 6.2.4 PSU MODE

If no battery is connected to the output terminals, the battery charger will operate as a DC power supply only, current limit is factory set to 5 A, 10 A or 15 A and is adjustable (2 A – 10 A DSE9470 & DSE9480 , 2 A – 15 A DSE9473 & DSE9483) using the DSE Configuration Suite PC Software. See the section entitled *Specification* elsewhere in this manual for further output specifications.

### 6.2.5 CHARGE MODE

**NOTE:** For details of Battery Charger Configuration, you are referred to DSE Publication: 057-159 DSE9400 Series Battery Charger Configuration Suite Manual.

**NOTE:** Should a 2-Stage charging profile be required, select a 3-Stage profile and configure **Boost Voltage** and **Float Voltage** to the same value.

Using DSE Configuration Suite PC Software, the battery charger is configured to use a 3-Stage Charge, or 4-Stage Charge, or 5-Stage Charge profile as shown below. The description of each charge mode is given in the following sections.

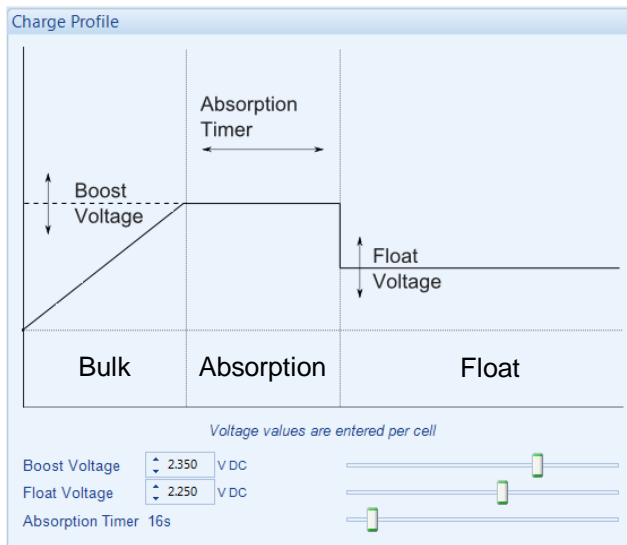

3-Stage Charge Profile Configuration

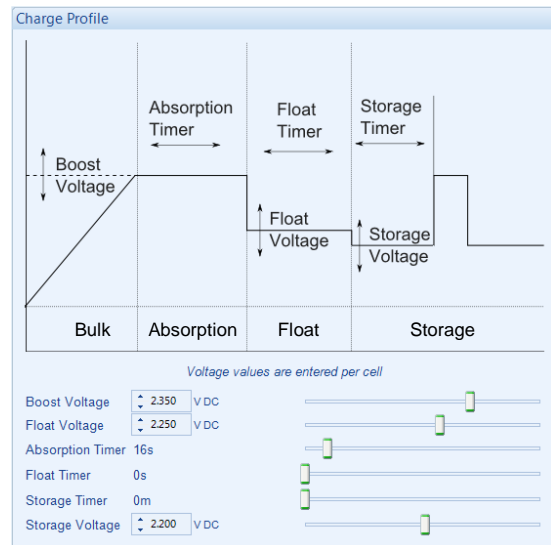

4-Stage Charge Profile Configuration

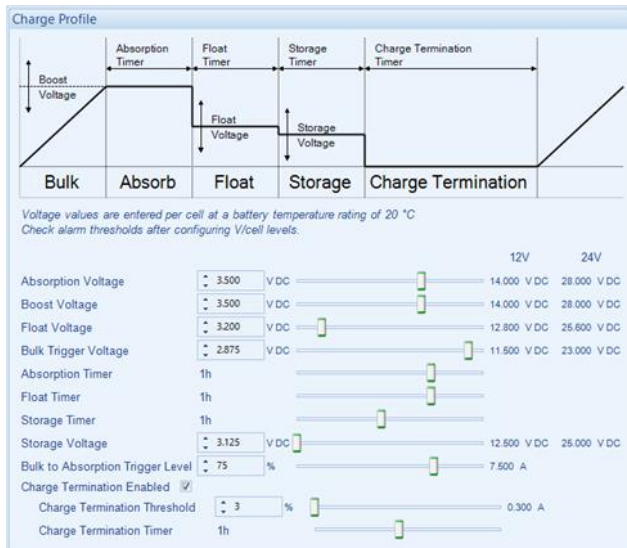

5-Stage Charge Profile Configuration

### 6.2.5.1 BULK CHARGE

The battery charger operates in *Constant voltage current limited* mode.

The charger output voltage is maintained at a constant level (*boost voltage*) to allow the battery to charge while the load does not exceed the maximum rating of the charger.

If the load on the battery charger (*battery charge demand+standing load*) exceeds the maximum current rating of the charger, the charging current is limited to the maximum rating of the charger and the voltage is reduced.

The voltage will rise to the rated voltage again once the load drops below the maximum rating of the charger. This may occur naturally as the battery charges.

As the battery charges and the charge current drops below the *Bulk to Absorption Trigger Level* percentage, *Absorption* mode is entered. The default *Bulk to Absorption Trigger Level* is 75%, configurable using the DSE Configuration Suite PC Software.

### 6.2.5.2 ABSORPTION

This mode is active for the duration of the *Absorption Timer*. This is adjustable using the DSE Configuration Suite PC Software.

Absorption mode is used to complete the charging process, bringing the battery to 100% charged status.

After the *Absorption timer*, *float charge* mode is entered.

### 6.2.5.3 FLOAT CHARGE

The battery charger DC voltage is lowered to the configured *float voltage*.

Float Charge is used to provide a small amount of current to the battery, to overcome internal losses and keep the battery at it's 100% charged state. The battery can be left in this mode indefinitely.

### 6.2.5.4 STORAGE

When configured to use a four stage charging profile, a time limited storage charge is periodically entered (*storage timer*) to maintain the battery charge at optimum levels. This occurs at the level of the *storage voltage*. This is adjustable using the DSE Configuration Suite PC Software.

When the *storage timer* expires, the charger re-enters the *Absorption* mode.

Additionally, this is used as an 'Automatic Boost' facility, to periodically attempt to remove sulfation from the battery plates.

### 6.2.5.5 CHARGE TERMINATION

When *Charge Termination* is enabled, the charger terminates the charging when the output current level decreases below the *Charge Termination Threshold* % level, and the charger remains off for the *Charge Termination Timer* time before exiting this stage. The *Charge Termination Threshold* and the *Charge Termination Timer* are configured using the DSE Configuration Suite PC Software.

The charger transfers back to the Bulk Stage when the *Charge Termination Timer* expires, or the output voltage drops below the *Bulk Trigger Voltage* level.

### 6.2.5.6 CHARGING TIME

Charge time is often of little consequence when the battery is used in a *standby* operation. An example of this is when the battery is used to supply the starting system of a diesel generator. During normal operation, the battery is at full capacity and the battery charger is used to maintain the float voltage of the battery. The battery is only drained when the generator is called to start. As the generator has a DC charging alternator fitted, the battery is quickly recharged when the generator is running. Should the generator stop before the battery is fully recharged, the DSE9400 MKII Series battery charger will continue to recharge the battery until it is fully charged.

Typically a battery will charge from flat to 80% capacity in 16 hrs when when charged at C/10. For example charging a 50 Ah battery for 16 hrs at 5 A will charge the battery to 80% of its full capacity.

Remember to take into account any other standing load such as control panel requirements when calculating how much power is 'left' to charge the battery.

### 6.2.5.7 MANUAL BOOST

 **NOTE: The Digital Input must be configured to *Manual Boost* to provide this function. For further details, you are referred to DSE Publication: 057-159 DSE9400 Series Battery Charger Configuration Suite Manual.**

Manual boost will place the charger into *Bulk Charge* mode, charging at the level of the *boost voltage*. A typical use of manual boost is with Lead Acid type batteries. When the battery is fully charged, placing the charger into boost mode will raise the output voltage. This has the effect of *gassing* the battery, helping to remove sulfation from the battery plates and helping the cells to *equalise* in voltage.

### 6.2.6 TEMPERATURE COMPENSATION

 **NOTE: For details of Battery Charger Configuration, you are referred to DSE Publication: 057-159 DSE9400 Series Battery Charger Configuration Suite Manual.**

If temperature compensation is enabled through configuration, and remote temperature sensor is connected, the output voltage automatically varies by a configureable voltage per cell for each 1 °C deviation from 20 °C, within the range of -20 °C to 60 °C. Increasing temperature gives decreasing output voltage and decreasing temperatures gives increasing output voltage..

The battery temperature is measured by a 2 wire PT1000 sensor placed on the battery itself.

## 7 FAULT DIAGNOSIS

Nature of problem	Suggestion
The charger is not operating	<p>Check that the incoming AC supply is correctly connected and within limits and check the integrity of any external fuse that may be fitted.</p> <p>Ensure the charger is not being operated above the maximum temperature specification.</p> <p>Check the LED indications against the LED descriptions listed elsewhere in this document.</p>
Charge fail relay continuously operated	Check the connected load of the charger is not reverse connected or short circuit.
Batteries fail to charge	Check the batteries using the battery manufacturers recommendations.
Charge time is too long	<p>Typically a battery will charge from flat to 80% capacity in 16 hrs when when charged at C/10.</p> <p>For example charging a 50 Ah battery for 16 hrs at 5 A will charge the battery to 80% of its full capacity.</p> <p>Remember to take into account any other standing load such as control panel requirements when calculating how much power is 'left' to charge the battery.</p>



## **8 MAINTENANCE, SPARES, REPAIR AND SERVICING**

The DSE battery chargers are designed to be *Fit and Forget*. As such, there are no user serviceable parts. In the case of malfunction you should contact your original equipment supplier (OEM).

## **9 WARRANTY**

DSE provides limited warranty to the equipment purchaser at the point of sale. For full details of any applicable warranty, you are referred to your original equipment supplier (OEM).

## **10 DISPOSAL**

### **10.1 WEEE (WASTE ELECTRICAL AND ELECTRONIC EQUIPMENT)**

If you use electrical and electronic equipment you must store, collect, treat, recycle and dispose of WEEE separately from your other waste.

This Page is Intentionally Blank